



WINDOW AIR CONDITIONER

WAT Series

OWNER'S MANUAL
OPERATOR'S MANUAL
TECHNICAL MANUAL

For models:

GJC06BK-A6NRNC5A

GJC06BK-A6NRNC5B

GJC08BK-A6NRNC5C

GJC08BK-A6NRNC5D

*Please read this owner's manual carefully
before operating the unit and keep it for future reference.*

IMPORTANT : The remote control and hardware necessary to use your new product is included inside the box. You will find them inserted in the Styrofoam included in the box.

TABLE OF CONTENTS

Operation Notices	3
Symbols meanings.....	3
Exception Clauses	4
The Refrigerant.....	5
Refrigerant Safety Precautions	6
General Safety Precautions.....	7
General Instructions for Use.....	10
Installation	12
Parts Name.....	12
Preparation for Installation	13
Installation Procedure.....	14
Control	19
Remote Control.....	19
Electronic Thermostat.....	22
Air Conditioner Use	23
Instructions for fan direction adjusting.....	24
Normal sounds.....	25
Maintenance	25
Cleaning and Maintenance.....	25
Maintenance Security Precautions	27
Additional Information for Maintenance.....	29
Malfunction Analysis	34
Assistance	38

OPERATION NOTICES

READ THIS MANUAL: Inside you will find many helpful hints on how to use and maintain your air conditioner properly. Just a little preventive care on your part can save you a great deal of time and money over the life of your air conditioner. You'll find many answers to common problems in the chart of troubleshooting tips. If you review our chart of Troubleshooting Tips first, you may not need to call for service at all.

Note: Graphics in this manual are only for reference. Please refer to actual products for specific details.

This appliance is not intended for use by people (including children) with reduced physical, sensory or mental capabilities, or lack of experience and knowledge, unless they have been given supervision or instruction concerning use of the appliance by a person responsible for their safety.

Children should be supervised to ensure that they do not play with the appliance.

CAUTION:

- Contact the authorized service technician for repair or maintenance of this unit.
- Contact the installer for installation of this unit.
- If the SUPPLY CORD is damaged, it must be replaced by the manufacturer, its service agent or similarly qualified people to avoid a hazard.
- Installation work must be performed in accordance with the national wiring standards and by authorized personnel only.

Symbols Meanings



Indicates a risk of fire, caution.



Indicates that before using the appliance, you must read the owner's manual.



Indicates that before installing the appliance, you must read the installation manual.



Indicates that before repairing the appliance, you must read the service manual.

General Warnings:



Indicates NEVER DO THIS.



Indicates ALWAYS DO THIS.

Safety Warnings:



Indicated hazardous situation that, if not avoided, will result in death or serious injury.



Indicated hazardous situation that, if not avoided, could result in death or serious injury.



Indicated hazardous situation that, if not avoided, may result in minor or moderate injury.



Indicates important but not hazard-related information, used to indicate risk of property damage.



Indicates a hazard that would be assigned the mention of WARNING or CAUTION.

Exception Clauses

Manufacturer will bear no responsibilities when personal injury or property loss is caused by the following reasons.

1. Damage to the product due to improper use or misuse of the product;
 2. Alter, change, maintain or use of the product with other equipment without abiding to the instruction manual of manufacturer;
 3. After verification, the defect of product is directly caused by corrosive gas;
 4. After verification, defects are due to improper operation during transportation of product;
 5. Operate, repair, maintain the unit without abiding to instruction manual or related regulations;
 6. After verification, the problem or defect is caused by the quality specification or performance of parts and components that are produced by other manufacturers;
 7. The damage is caused by natural calamities or used in a bad environment.
- If you need to install, move or maintain the air conditioning, please contact the retailer or local service center first. The air conditioning must be installed, moved or maintained by an authorized representative. Otherwise, it could cause serious damage, serious injury or even death.
 - If the refrigerant leaks or requires draining during installation, maintenance or disassembly, a certified professional should be called to take care of the situation.

The Refrigerant

To have a functional air conditioning unit, a special refrigerant circulates in the system. The used refrigerant is the fluoride R32, which is specially cleaned. The refrigerant is flammable and inodorous. Furthermore, it can lead to explosion under certain conditions. But the flammability of the refrigerant is very low. It can be ignited only by fire.

Compared to common refrigerants, R32 is a nonpolluting refrigerant with no harm to the ozone. The greenhouse emissions are also lower. R32 has very good thermodynamic features which leads to a high energy efficiency. The unit therefore needs less filling.

WARNING

- Keep ventilation openings clear of obstruction.
- Do not use means to accelerate the defrosting process or to clean, other than those recommended by the manufacturer.
- Should repair be necessary, contact a qualified technician. Any repairs carried out by unqualified personnel may be dangerous.
- For repairs, strictly follow manufacturer's instructions only.
- Appliance shall be installed, operated and stored in a room with a floor area larger than the recommended area (Please refer to table "1" in section of "Refrigerant Safety Precautions").
- The appliance shall be stored in a room without continuously operating ignition sources (for example: open flames, an operating gas appliance or an operating electric heater).
- Do not pierce or burn the unit.
- Appliance is filled with flammable gas R32.
- Be aware that refrigerants do not contain odor.
- When maintaining or disposing the unit, the refrigerant inside the system must be eliminated. Refrigerant should be recovered. It can't be discharged freely.
- No open fire (fired equipment such as electrical heater and gas stove etc.) or any equipment (e.g. switch) that might generate arc should be around the appliance.

NOTE: Anyone who is involved with working on or breaking into a refrigerant circuit should hold a current valid certificate from an industry-accredited assessment authority, which authorizes their competence to handle refrigerants safely in accordance with an industry recognized assessment specification. Servicing shall only be performed as recommended by the equipment manufacturer. Maintenance and repair requiring the assistance of skilled personnel shall be carried out under the supervision of the person competent to use flammable refrigerants.



Refrigerant Safety Precaution

Qualification requirement for installation and maintenance

Everyone who is working with a refrigeration system should bear the valid certification awarded by the authorized organization and the qualification for dealing with the refrigeration system recognized by this industry.

Installation reminders

- The air conditioner cannot be installed in a room that has running fire or such fire source.
- The air conditioner must be installed in a room that is larger than the minimum room area. (See Table 1 below).
- Leak test is a must after installation.

Table 1: Minimum room area (m²)

Charge amount (kg)	≤1.2	1.3	1.4	1.5	1.6	1.7	1.8	1.9	2.0	2.1	2.2	2.3	2.4	2.5
Floor location	/	14.5	16.8	19.3	22.0	24.8	27.8	31.0	34.3	37.8	41.5	45.4	49.4	53.6
Window mounted	/	5.2	6.1	7.0	7.9	8.9	10.0	11.2	12.4	13.6	15.0	16.3	17.8	19.3
Wall mounted	/	1.6	1.9	2.1	2.4	2.8	3.1	3.4	3.8	4.2	4.6	5.0	5.5	6.0
Ceiling mounted	/	1.1	1.3	1.4	1.6	1.8	2.1	2.3	2.6	2.8	3.1	3.4	3.7	4.0

Welding Instructions - Must be done by a qualified technician

If you should cut or weld the refrigerant system pipes during maintenance, please follow the steps below:

1. Shut down the unit and cut power supply.
2. Eliminate the refrigerant.
3. Vacuum.
4. Clean it with N2 gas.
5. Cut or weld.
6. Carry back to the service spot for welding.

NOTE: The refrigerant should be recycled into a specialized storage tank.



WARNING: Make sure there isn't any naked flame near the outlet of the vacuum pump and that is well-ventilated.

Instructions to fill the Refrigerant- Must be done by a qualified technician

1. Use the refrigerant filling appliances specialized for R32. Make sure that different kinds of refrigerant won't contaminate with each other.
2. The refrigerant tank should be kept upright at the time of filling refrigerant.
3. Stick the label on the system after filling is finished.
4. Don't overfill.
5. After filling is finished, please do the leakage detection test before using the unit.

General Safety Precautions

To prevent injury to the user or other people and property damage, the following instructions must be followed. Incorrect operation may cause harm or damage.

- ❗ Plug in power plug properly. Otherwise, it may cause electric shock or fire due to excess heat generation.
- ❗ Always ensure effective grounding. Incorrect grounding may cause electric shock.
- ❗ Unplug the unit if strange sounds, smell or smoke comes from it.
- ❗ Keep firearms away. It may cause fire.
- ❗ Ventilate room before operating air conditioner if there is a gas leakage from another appliance. It may cause explosion, fire and burns.
- ❗ Always install circuit breaker and a dedicated power circuit. Incorrect installation may cause fire and electric shock.
- ❗ Ensure that the installation bracket of the outdoor appliance is not damaged due to prolonged exposure.
- ❗ Ventilate the room well when used together with a stove, as an oxygen shortage may occur.
- ❗ When the unit is to be cleaned, switch off and turn off the circuit breaker.
- ❗ Stop operation and close the window in a storm or hurricane.
- ❗ Turn off the main power switch when not using the unit for a long time. It may cause failure of product or fire.
- ❗ Always insert the filters securely. Clean the filter once every two weeks. Operation without filters may cause failure.
- ❗ Use a soft cloth to clean the unit.
- ❗ If water enters the unit, turn the unit off at the power outlet and switch off the circuit breaker. Isolate supply by taking the power plug out and contact a QUALIFIED SERVICE TECHNICIAN.
- ❗ Use caution when unpacking and installing. Sharp edges could cause injury.
- ❗ Maintenance must be performed by qualified professionals. Otherwise, it may cause personal injury or damage.



WARNING

- ⊗ Do not place obstacles around air-inlets or inside of air-outlets. It may cause failure of appliance or an accident.
- ⊗ Do not operate or stop the unit by inserting or pulling out the power plug. It may cause electric shock or fire due to heat generation.
- ⊗ Do not damage or use an unspecified power cord.
- ⊗ If the power supply wire is damaged, it must be replaced by a qualified person in order to avoid a hazard.
- ⊗ Do not modify power cord length or share the outlet with other appliances. It may cause electric shock or fire due to heat generation.
- ⊗ Do not hold the plug by the head when taking it out. It may cause electric shock and damage.
- ⊗ Do not use strong detergent such as wax or thinner to clean the unit. The appearance may be deteriorated due to change of product color or scratching of the surface.
- ⊗ Do not operate with wet hands or in damp environment. It may cause electric shock.
- ⊗ Do not direct airflow at room occupants directly. It could damage your health.
- ⊗ Do not allow water to run into electric parts. It may cause failure of machine or electric shock.
- ⊗ Do not use the socket if it is loose or damaged. It may cause fire or electric shock.
- ⊗ Do not use the power cord close to heating appliances. It may cause fire or electric shock.
- ⊗ Do not use the power cord near flammable gas or combustibles, such as gasoline, benzene, thinner, etc. it may cause an explosion or fire.
- ⊗ Do not disassemble or modify unit. It may cause failure or electric shock.
- ⊗ Do not open the unit during operation. It may cause electric shock.
- ⊗ When the air filter is to be removed, do not touch the metal parts of the unit. It may cause injury.
- ⊗ Do not clean the air conditioner with water. Water may enter the unit and degrade the insulation. It may cause electric shock.
- ⊗ Do not place heavy objects on the power cord and ensure that the power cord is not compressed. There is danger of fire or electric shock.
- ⊗ Do not drink water drained from air conditioner. It contains contaminants and could make you sick.
- ⊗ Do not put a pet or house plant where it will be exposed to direct air flow. This could cause injury.
- ⊗ Do not use for special purposes (i.e. preserve precision devices, food, pets, plants and art objects). It may cause deterioration of quality, etc.
- ⊗ Do not clean unit when power is on as it may cause fire and electric shock. It may cause an injury.
- ⊗ Do not connect air conditioner to multipurpose socket. Otherwise, it may cause fire hazard.
- ⊗ Do install the air switch ((thermal-magnetic breaker). If not, it may cause malfunction.
- ⊗ Do not spill water on the remote controller, otherwise the remote controller may be broken.
- ⊗ Do not spray water on air conditioner. It may cause electric shock or malfunction.
- ⊗ Do not extend fingers or objects into air inlet or air outlet. It may cause personal injury or damage.
- ⊗ Do not step on or put heavy objects on air conditioner. It may cause damage or personal injury.



WARNING

The power supply cord with this air conditioner contains a current detection device designed to reduce the risk of fire. Please refer to the section “Instructions for use” for details.

If the power supply cord is damaged, it cannot be repaired. It must be replaced with a cord from the product manufacturer.



WARNING

For your safety

- Do not store or use gasoline or other flammable vapors and liquids near this or any other appliance.
- Avoid fire hazard or electric shock. Do not use an extension cord or an adaptor plug. Do not remove any prong from the power cord.

Electrical Information

- Be sure the electrical service is adequate for the model you have chosen. This information can be found on the serial plate, which is located on the side of the cabinet and behind the grill.
- Be sure the air conditioner is properly grounded. To minimize shock and hazards, proper grounding is important. The power cord is equipped with a three-prong grounding plug for protection against shock hazards.
- Your air conditioner must be used in a properly grounded wall receptible. If the wall receptible you intend to use is not adequately grounded or protected by a time delay fuse or circuit breaker, have a qualified electrician install the proper receptible.
- Ensure the receptible is accessible after the unit installation.
- Do not run air conditioner without side protective cover in place. This could result in mechanical damage within the air conditioner.
- Do not, under any circumstances, cut, remove or bypass the grounding prong.
- Do not use an extension cord or an adapter plug.

General Instructions for Use

Power supply

The power supply cord contains a current device that senses damage to the power cord. To test your power supply cord, do the following:

1. Plug in the Air Conditioner.
2. The power supply cord will have TWO buttons on the plug head. Press the TEST button, you will notice a click as the RESET button pops up.
3. Press the RESET button, again you will notice a click as the button engages.
4. The power supply cord is now supplying electricity to the unit. (On some products this is also indicated by a light on the plug head.)

NOTICE:

- Do not use this device to turn the unit on or off.
- Always make sure the RESET button is pushed in for correct operation.
- The power supply must be replaced if it fails reset when either the TEST button is pushed, or it cannot be reset. Please contact customer service.
- If power supply cord is damaged, it cannot be repaired. It **MUST** be replaced with a new cord. Please contact customer service.

NOTE: The power cord of window type unit has creepage protection device.

There is a test button and a reset button on the plug. You are suggested to check the power cord periodically.

Check method: After putting through the power, the indicator is ON. After pressing the TEST button, the indicator is OFF and you can hear a sound. Then press the RESET button, the indicator will be ON, which indicates the protection device is normal.

NOTE: Plug may be different with the actual product. Please refer to actual product.

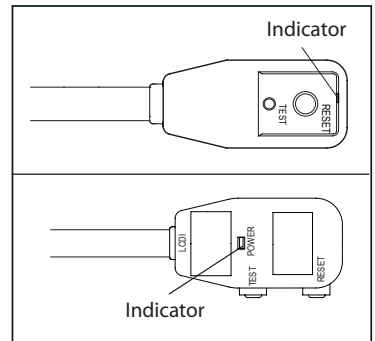

Operating temperature range

	Indoor side DB/WB (°C/°F)	Outdoor side DB/WB (°C/°F)
Maximum Cooling	40°C (104°F) / 26.7°C (80°F)	40°C (104°F) / 26.7°C (80°F)

The operating temperature range (outdoor temperature) for cooling unit only is 18°C to 40°C (64.4°F to 104°F).



WARNING

Security precautions

1. You must follow the electric safety regulations when installing the unit.
2. According to the local safety regulations, use a qualified power supply circuit and air switch (thermal-magnetic breaker).
3. Make sure the power supply matches with the requirement of air conditioner. Unstable power supply or incorrect wiring may result in electric shock, fire hazard or malfunction.
4. Properly connect the live wire, neutral wire and grounding wire of power socket.
5. Be sure to cut off the power supply before proceeding any work related to electricity and safety.
6. Do not put the power on before finishing installation.
7. The air conditioner is a first-class electric appliance. It must be properly grounded. Please make sure it is always grounded effectively, otherwise it may cause electric shock.
8. Do not use for other purposes the yellow-green wire or green wire in air conditioner other than for grounding.
9. The grounding resistance should comply with national electric safety regulations.
10. Make sure the power supply complies with the requirement of air conditioner. Unstable power supply or wrong wiring may lead to electric shock.

Electric wiring

- Must connect with ground reliably.
- The exclusive circuit must be used. But removable socket can't be used because poor contact of it can cause overheat or cause fire.
- Don't pull the power cord strongly.
- Connecting method between air conditioners and power cord and interconnecting method of each individual element with one another should be done according to the wiring diagram on the unit.
- The air conditioner should be installed in accordance with national wiring regulation.
- An all-pole disconnection switch having a contact separation of at least 3 mm (1/8") in all poles should relate to fixed wiring.
- Air switch (thermal-magnetic breaker) should be installed in the circuit.

INSTALLATION



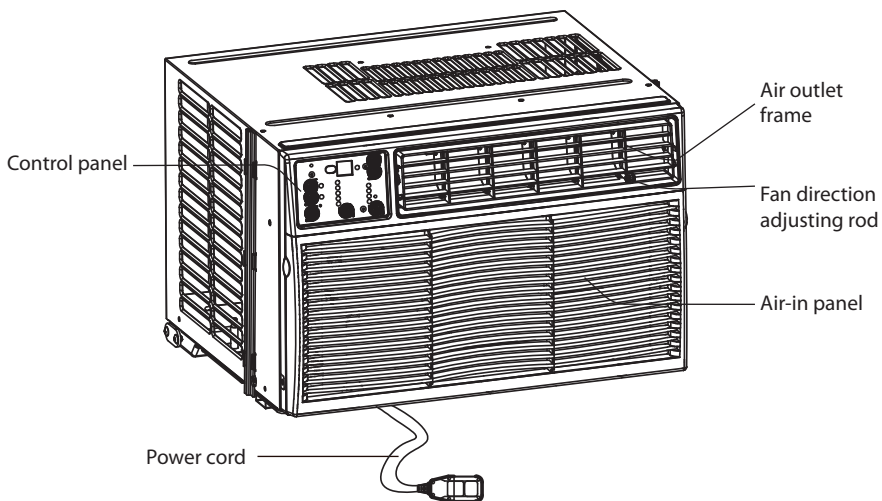

Parts Name

NOTE: Panel outlook picture, just for reference, please take the real unit as standard.



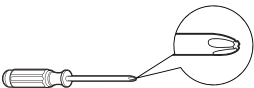



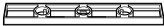
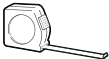

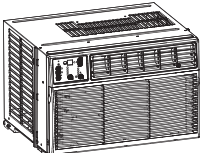
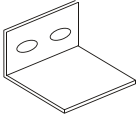
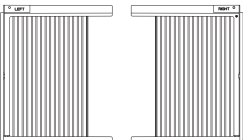
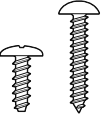

Preparation for Installation

Tools for installation

Phillips screwdriver		Scissors	
Screwdriver		Pencil	
Level bar		Measuring tape	

Components included in the box - may vary from model to model

Window type unit		Sash lock	
Flexible screen		Type A screws(4) And Type B screws(6)	
Sealing strip (with adhesive)		Sponge	
Sealing strip (without adhesive)		Upper guide rail	
Remote controller		Batteries	
User Manual			

Installation Procedure

Location

How to install:

- Choose a location where there are no obstacles surrounding the unit, and where the plug is easily accessible.
- Choose the installation space according to Figure A. The distance of obstructions from the inside window unit should respect the dimensions indicated on Figure A.

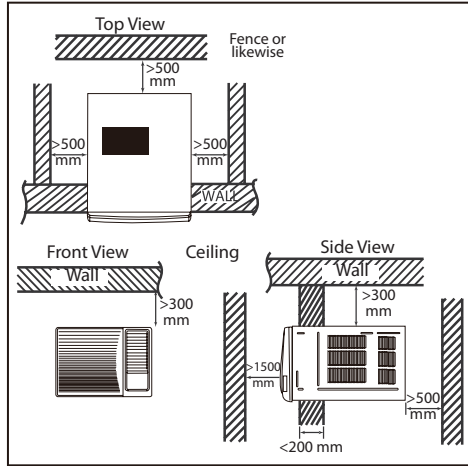

Figure A

Basic requirements of location:

- Should not be near a place with strong heat sources, vapors, flammable or explosive gas, or volatile objects spread in the air.
- Should not be near a place with high-frequency devices (such as welding machine, medical equipment).
- Should not be near a place with oil or fumes in the air.
- Should not be near a place with sulfurated gas.
- There should be no obstruction near air inlet and air outlet.
- Select a location where the condensation water can be dispersed easily and won't affect other people.
- The location should be able to withstand the weight of the unit and won't increase noise and vibration.
- Try to keep far away from fluorescent lamp.

NOTE: The upper guide rail and the side panels are offset to provide the proper pitch to the rear of (5/16" or 7.9375 mm). This is necessary for proper condensed water utilization and drainage. Even if you are not using the side panels, the rear pitch must be maintained!

Step 1:

Find the upper rail in the component set included in the packaging. Tear off the paster (sponge) on the back of the upper rail. Install the upper rail above the cabinet, make sure the holes are aligned to secure the upper rail to the outer case of air conditioner with 4 Type A screws.

NOTICE: The window will close down into this upper guide rail and be one of the air conditioner anchor points (in step 5).

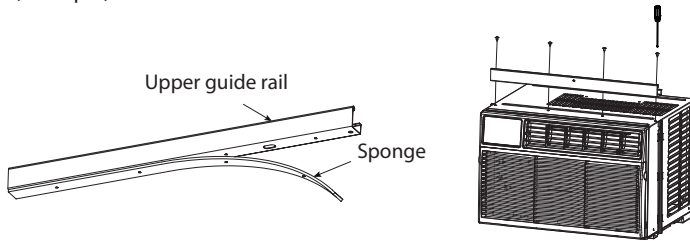

Step 2:

Place unit on floor, a bench or a table. There is a Left-side and Right-side Filler Panel. Be sure to use the proper panel for each side. When installed, the flange for securing the panel in place in the windowsill will be facing into the room.

- a. Hold the side Panel in one hand and gently pull back the center to free the open end. See Figure 1.

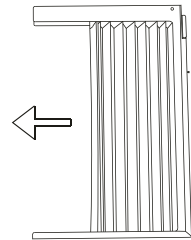

Figure 1

- b. Slide the free end "T" section of the panel directly into the cabinet as shown in Figure 2. Slide the panel down. Be sure to leave enough space to slip the top and bottom of the frame into the rails on the cabinet.

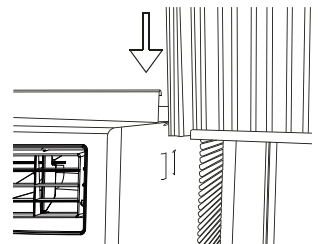

Figure 2

- c. Once the panel has been installed on the side of the cabinet, make sure it sits securely inside the frame channel by making slight adjustments. Slide the top and bottom ends of the frame into the top and bottom rails of the cabinet. See Figure 3.

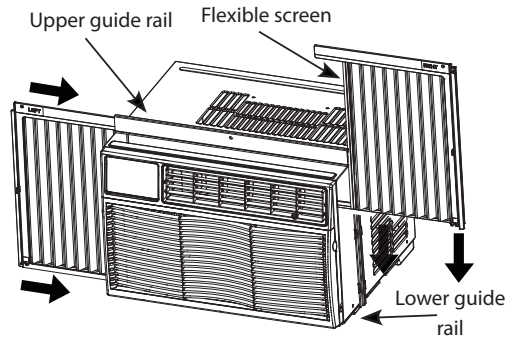

Figure 3

- d. Slide the panel all the way in and repeat on the other side.

NOTE: Your air conditioner is designed to install in standard double hung windows with opening widths of 22" to 36" (55.88 to 91.44 cm) (Figure 4A). Lower sash must open sufficiently to allow a clear vertical opening of minimum 13 1/4" (33.7 cm). Side louvers and the rear of the air conditioner must have clear air space to allow enough airflow through the condenser, for heat removal. The rear of the unit must be outdoors, not inside a building or garage.

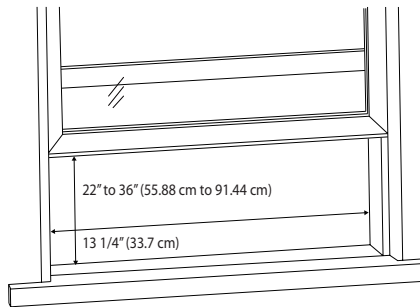

Figure 4

Step 3:

If your window is a weather-proof type window, the frame will not allow the air conditioner to tilt properly (see step 5), which will prevent the unit from draining properly. In this case, before installing the air conditioner, add wooden strap on the windowsill, and fix the wooden strap to the windowsill.

Specification of wooden strap (see Figure 5):

- Width: about 2" (5.08 cm).
- Length: same to the inner frame size of window.
- Height: Put the wooden strap on the windowsill, top part of wooden strap and window frame should be at the same horizontal level, or higher than the top part of window frame for about 1/4" - 1/2" (6.35 mm - 12.7 mm).

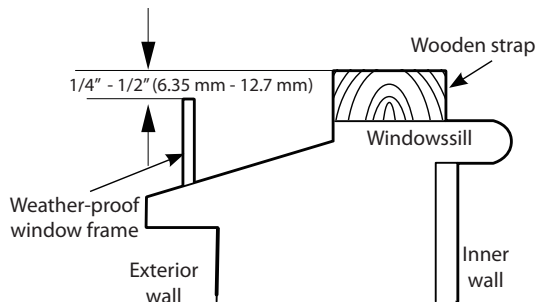

Figure 5

Step 4:

Cut the sealing strip into proper length. Stick the sealing strip to the lower part of the window frame (see Figure 6).

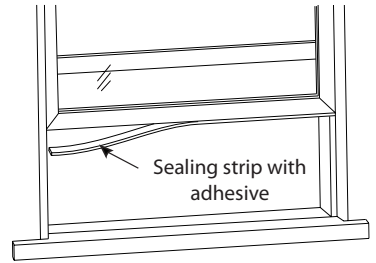

Figure 6

Step 5:

2 persons should work together to put the air conditioner into the window opening so the bottom of the air conditioner frame is against the windowsill.

Upper guide rail stays at the middle lower side of window and then window can stick to the upper guide rail when closing it.

Please note that the air conditioner should be placed at horizontal place or inclined outwards slightly.

Carefully close the window behind the top rail of the unit.

Check that air conditioner is tilted back about 1/4" to 1/2" (6.35 mm - 12.7 mm) (tilted about 3° downward to the outside, see Figure 7A and Figure 7B). After proper installation, condensate should not drain from the overflow drain hole during normal use, correct the slope otherwise.

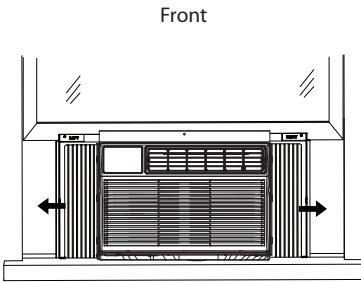

Figure 7A

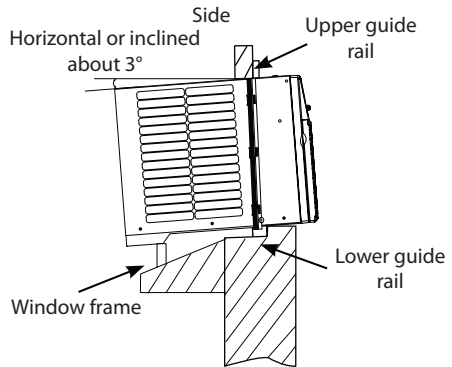

Figure 7B

Step 6:

Extend the side panels out against the window frame and use 5 type B screws to fix the panels on the windowsill.

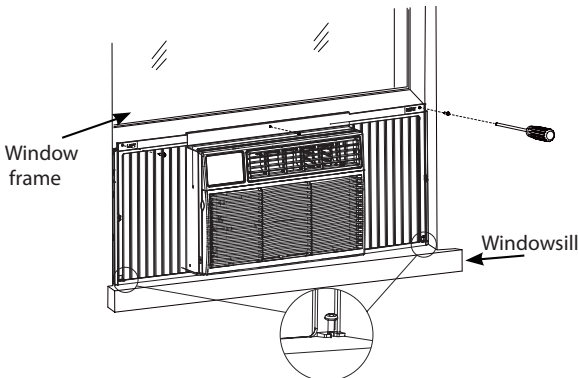

Figure 8

Step 7:

To secure lower sash in place, attach right angle sash lock with screw as shown.

NOTE: It is difficult to lock the windows with the sash lock for Vinyl-Clad windows, so you can use window itself to lock.

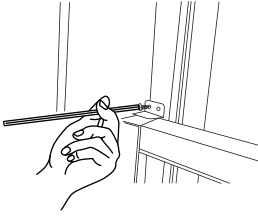

Figure 9A

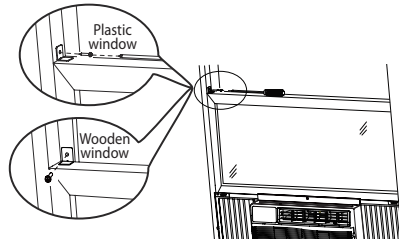

Figure 9B

Step 8:

Cut the sealing strip the length of window. Plug the sealing strip between glasses and window to prevent rain and insects getting into the room (Figure 10).

NOTE: If the sealing strip is not suitable for your window, it can be replaced.

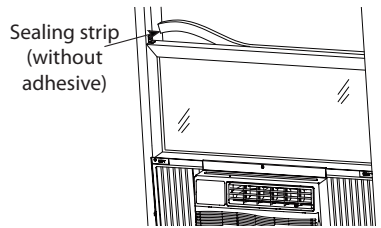

Figure 10

Step 9:

Trim the weather seal with a proper length peel off the protective backing and plug any gaps if needed as shown Figure 11.

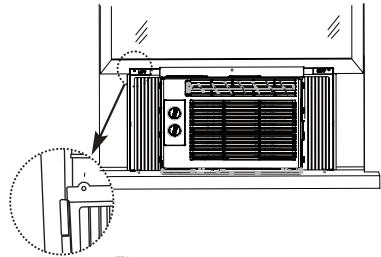

Figure 11

Step 10:

To achieve maximum cooling efficiency, the air conditioner is designed to project its condensation onto its condenser coil. If you are bothered by the splash noise, you can create an exterior drain as follows, but this may cause a slight loss in performance.

- a. The air conditioner has the drainage gasket (Figure 12A).
- b. Remove the drainage gasket from the body base plate (Figure 12B).

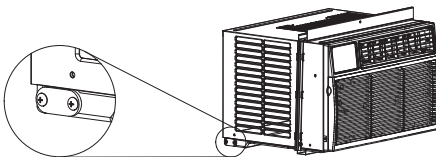

Figure 12A

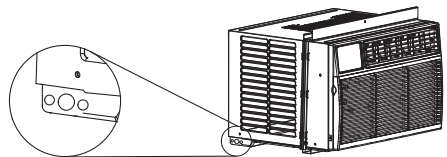

Figure 12B

Removing the air conditioner from window

1. Turn the air conditioner off and disconnect power cord.
2. Remove sash seal from between windows and unscrew sash lock.
3. Remove screws installed through frame and frame lock.
4. Close (slide) side panels into frame.
5. Keeping a firm grip on air conditioner, raise sash and carefully remove.
6. Be careful not to spill any condensate water while lifting unit from window.
7. Store parts WITH air conditioner.

CONTROL

Operating your air conditioner properly helps you obtain the best possible results. This section explains proper air conditioner operation.

IMPORTANT:

- If you turn off the air conditioner, wait at least 3 minutes before turning it back on. This prevents the air conditioner from blowing a fuse or tripping a circuit breaker.
- Do not try to operate your air conditioner in the cooling mode when outside temperature is below 65 °F (18°C). The inside evaporator coil will freeze up, and the air conditioner will not operate properly.

NOTE: In the event of a power failure, your air conditioner will operate as the previous settings when the power is restored.

Remote Control

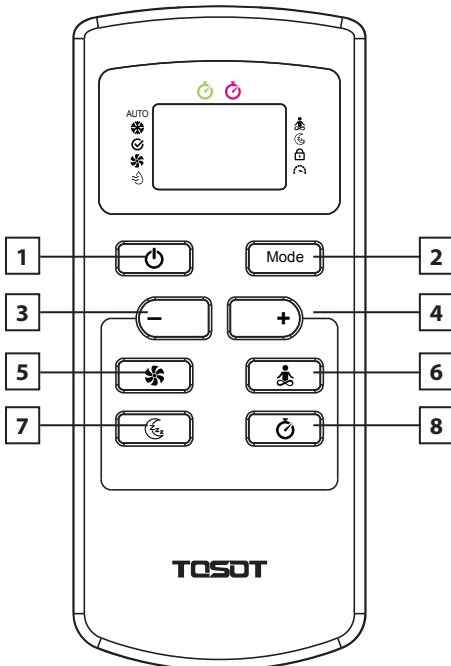

NOTE: This is a general purpose remote control it could be used for air conditioners with multi-function.

Instructions for remote control use:

- The distance between signal sender and receiving window should be no more than 6 m (16.69 ft.), and there should be no obstacles between them.
- Replace new batteries of the same model when replacement is required.
- When you don't use the remote control for a long time, please take out the batteries.

1. POWER BUTTON

Press On/Off button to turn on or turn off the unit.

NOTE: Press this button to turn on air conditioner, the unit will operate in Energy Saver mode. If the unit is energized after power failure, the unit will still operate according to the status before power failure.

2. MODE BUTTON

Each time you press the button, a mode is selected in a sequence that goes from AUTO, COOL, SAVE (Energy Saver), FAN and DRY as the following:



3. (-) BUTTON

Press the (-) button once to decrease the set temperature.

Press this button to decrease the set temperature. Pressing this button for 2 continuously seconds will decrease the temperature quickly.

In AUTO mode, the setpoint temperature cannot be adjusted.

4. (+) BUTTON

Press the (+) button once to increase the set temperature.

Press this button to increase the set temperature. Pressing this button for 2 continuously seconds will increase the temperature quickly.

In AUTO mode, the setpoint temperature cannot be adjusted.

5. FAN

This button is used to adjust the fan speed in a sequence from AUTO, speed 1, speed 2, speed 3 then back to AUTO.



6. I FEEL

Once this function is settled, remote control sends the information about room temperature to the control panel and will adjust automatically. Press again this button to cancel I FEEL function and the icon disappears.

Please put remote control near the user when this function is chosen. Do not put remote control near something at high or low temperature in order to prevent false results.

Make sure to keep the minimum distance recommended between the remote control and the appliance.

After 11 minutes, if the air conditioner does not receive this value from the remote control, the unit will operate with the room temperature according to the air conditioner; this data will not be as precise as the one send by the remote control.

NOTE: The remote control must point at the indoor unit receiving window at all time so that the control signal is received by the unit.

7. SLEEP

Press this button to reach "sleep" mode. Press again to control this function.

By activating this function, the air conditioner will stop working once the room temperature is reached. Press again to cancel this function. This function is available in COOL or DRY or SAVE Mode.

8. TIMER

Press this button to activate the timer. To cancel the automatic timer, press this button twice.

ON: When the unit is off, you can set the time for auto on in the range from 0.5h to 24h.

OFF: When the unit is on, you can set the time for auto off in the range from 0.5h to 24h.

Replacement of Batteries in Remote Controller

1. See the back of the remote control.
2. Replace with two #7 (AAA 1.5V) dry batteries.
3. Make sure positions for "+" pole and "-" pole are correct.
4. Reinstall batteries box cover.

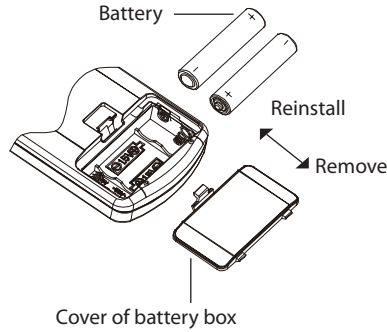

Electronic Thermostat

NOTE: The controls featured in this manual are representative of many available models. Your model may offer slightly different features.

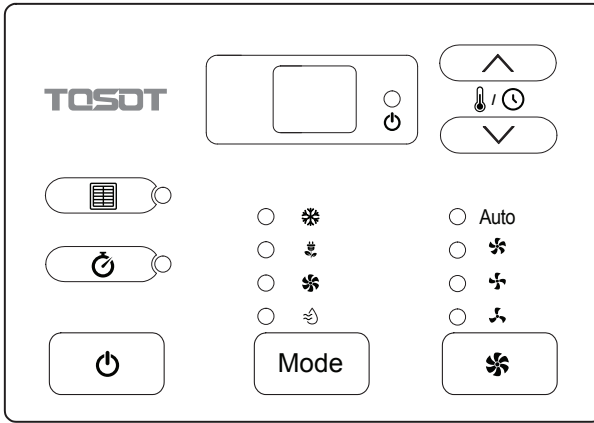

1. POWER BUTTON

Press On/Off button to turn on or turn off the unit

NOTE: Press this button to activate the air conditioning. The unit will operate in "energy saving" mode.

2. MODE BUTTON

Press Mode button to set air conditioner to Cool, Energy Saver, Fan Only or Dry mode.

Auto: Under this mode, the unit will operate automatically according to ex-factory setting. In this case, set temperature cannot be adjusted.

Cool: Under this mode, air conditioner operates under cooling mode. Cooling indicator will be on. In this mode it is possible to adjust the fan speed by pressing on "Fan Speed".

Energy Saver: Under this mode, air conditioner operates under Energy Saver mode. Energy Saver indicator will be on. In this mode it is possible to adjust the fan speed by pressing on "Fan Speed".

Fan Only: Under this mode, air conditioner will not cool or heat. Fan indicator will be on. In this mode it is possible to adjust the fan speed by pressing on "Fan Speed".

Dry: Under this mode, the unit runs in low fan speed for dehumidification and the corresponding indicator is on; under dry mode, the fan speed cannot be adjusted.

3. FAN SPEED BUTTON

Press this button to select the wanted fan speed. Corresponding speed indicator will be on.



4. TIMER BUTTON

TIMER ON : When the unit is off, you can set the timer for auto on in the range from 0.5h to 24h. After the time has elapsed, the unit will operate under the Energy Saver mode.

TIMER OFF : When the unit is on, you can set the time for auto off in the range from 0.5h to 24h. After the time has elapsed, the unit will turn off.



The timer can be set by 0.5 hour intervals below 10 hours and in 1 hour intervals for 10 hours or above.

5. FILTER CHECK

After the fan rotates for a total of 250h, the lamp of cleaning filter is on to remind you to clean it.

NOTE: After cleaning the filter, press the Filter Check button to clear the operation time. Meanwhile, the warning indicator will turn off.

6. / BUTTON

Pressing  or  button once will increase or decrease set temperature. The set light will turn on while setting.

7. DISPLAY

1. Under ON status without timer setting, the operation mode is AUTO, COOL, Energy Saver Dry mode, and the set temperature will be displayed.
2. Under ON status without timer setting, the operation mode is fan mode and the ambient temperature will be displayed.
3. Time will be displayed under timer setting or timer preview.

AIR CONDITIONER USE

An electronic thermostat is used to maintain the room temperature. The compressor will cycle on and off to keep the room at the set level of comfort. Set the thermostat at a lower number and the indoor air will become cooler. Set the thermostat at a higher number and the indoor air will become warmer.

NOTE: If the air conditioner is off and is then turned on while set to a **Cool** setting or if turned from a fan setting to a **Cool** setting, it may take approximately 3 minutes for the compressor to start and cooling to begin.

Example of settings:

- **For Normal Cooling**—Select the Cool mode with a High or Med fan and a middle set temperature.
- **For Maximum Cooling**—Select the Cool mode with a High fan and a lower set temperature.
- **For a Quieter & Nighttime Cooling**—Select the Cool mode with Low fan and a middle set temperature.

Energy Saver Mode

The fan will cycle on and off with the compressor. This results in wider variations of room temperature and humidity. Normally used when the room is unoccupied.

NOTE: The fan may continue to run for a short time after the compressor cycles off.

Fan Only Mode

Use this mode to provide air circulation and filtering without cooling. Since fan only settings do not provide cooling, a temperature cannot be entered. The room temperature will appear in the display.

NOTE: Auto Fan Speed cannot be used with the **Fan Only** Mode.

Auto Fan Speed

Set to Auto Fan Speed Mode for the fan speed to automatically set to the speed needed to provide optimum comfort settings with the set temperature. If the room needs more cooling, the fan speed will automatically increase. If the room needs less cooling, the fan speed will automatically decrease.

NOTE: Auto Fan Speed cannot be used with the **Fan Only** Mode..

Power Outage Recovery Feature

In the case of a power outage or interruption, the unit will automatically re-start in the settings last used after the power is restored. If the TIMER feature was set, it will countdown according to the memorized time. You may need to set a new time if desired.

Instructions for fan direction adjusting

You can adjust the fan direction with a Auger Type Rod (rotate the Auger Wheels until the desired Left/Right direction is obtained).

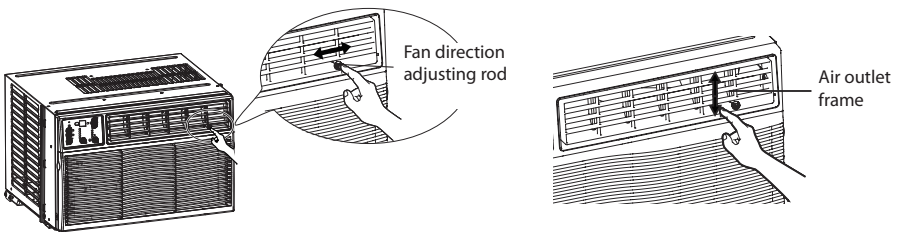

Normal Sounds

When your air conditioner is operating normally, you may hear sounds such as:

- Droplets of water hitting the condenser, causing a pinging or clicking sound. The water droplets help cool the condenser.
- Air movement from the fan.
- Clicks from the thermostat cycle.
- Vibrations or noise due to poor wall or window construction.
- A high-pitched hum or pulsating noise caused by the modern high-efficiency compressor cycling on and off.

MAINTENANCE

Cleaning and Maintenance



WARNING

Please always wait 3 minutes when turning unit off and then on again, and when changing from cool to fan and back to cool. This prevents the compressor from overheating and possible circuit breaker tripping.

To ensure optimal operation and maintain a good appearance, clean your air conditioning occasionally. **Be sure to unplug the unit before cleaning to prevent shock or fire hazards.**

Do not use volatile liquid to clean the air conditioner.

Air Filter Cleaning

The air filter should be checked at least once a month to see if cleaning is necessary. Trapped particles in the filter can build up and cause an accumulation of frost on the cooling coils.

To clean air filter:

1. Open the front panel and pull toward you both sides firmly.
2. Remove the filter.
3. Use a dishwashing liquid detergent and warm water to wash filter. Rinse filter thoroughly. Gently shake excess water from the filter. Be sure that the filter is dry before replacing. You may also, very gently vacuum the filter to clean it.
4. Install the filter and close the panel cover securely.

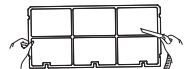
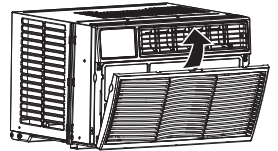
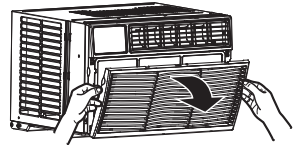

Cabinet Cleaning

NOTE: Be sure to unplug the air conditioner to prevent shock or fire hazard.

WARNING: Never use harsh cleaners, wax or polish on the cabinet front.

1. The cabinet and front may be dusted with an oil-free cloth or wash with a cloth dampened in dishwashing liquid detergent and warm water.
2. Rinse thoroughly and wipe dry.
3. Be sure to wring excess water from the cloth before wiping around the controls. Excess water in or around the controls may cause damage to the air conditioner.
4. Once cleaning is done, plug back the air conditioner.

Cleaning the Front Panel

NOTE: Do not remove the panel when cleaning it.

1. Unplug air conditioner or disconnect power.
2. Clean front panel with a soft dry or wet cloth.
3. Air dry front panel completely.
4. Plug in air conditioner or reconnect power.

Repairing Paint Damage

Check once or twice a year for paint damage. This is very important, especially in areas near oceans or where rust is problem. If needed, touch up with a good grade enamel paint.

NOTE: To reduce paint damage during the winter, install a heavy-duty cover over air conditioner cabinet.

Annual Maintenance

Your air conditioner needs annual maintenance to help ensure steady, top performance throughout the year. Call your local authorized dealer to schedule an annual checkup. The expense of an annual inspection is your responsibility.

Winter Storage

If you plan to store the air conditioner during the winter, remove it carefully from the window according to the installation instructions. Cover it with plastic or return it to the original carton.

Qualifications of Workers

Qualification of the working personnel for maintenance, service and repair operations should according to CAS/UL 60335-2-40:17 Annex HH. Every working procedure that affects safety means shall only be carried out by competent persons according to Annex HH. Special training additional to usual refrigerating equipment repair procedures is required when equipment with FLAMMABLE REFRIGERANTS is affected.

Maintenance Security Precautions

- ❶ Check whether the maintenance area or the room area meets the requirement on the name plate. It's only allowed to be operated in the rooms that meet the requirements on the name plate.
- ❷ Check whether the maintenance area is well-ventilated. The continuous ventilation status should be kept during the operation process.
- ❸ Check whether there is a fire source or potential fire source in the maintenance area. The naked flame is prohibited in the maintenance area. The no-smoking sign should be hanged.
- ❹ Check whether the appliance mark is in good condition. Replace the vague or damaged warning mark.

Storing the unit

1. Do not puncture or light the unit.
2. The unit shall be stored in a room without continuous fire source (e.g. naked fire, litten gas appliance, operating electric heater).
3. The unit shall be stored in a ventilated place; the ventilation device shall operate normally, and ventilation port shall be without obstacle.
4. Check the unit periodically to see if there is collision mark and if the appearance is good.
5. Check the electronic components (e.g. cable) periodically to see if there is breakage.
6. Do not collapse the unit to avoid leakage of refrigerant; if leakage is found, please arrange ventilation immediately and ask professionals for maintenance, to avoid a fire hazard.

Disposing and recycling of the unit - Must be done by a qualified technician

Disposal:

The technician shall be familiar with the device and all its characteristics before disposal. Proceeding to safe recycling of refrigerant is recommended. If the recycled refrigerant shall be utilized, please analyze the sample of refrigerant and oil before proceeding. Please ensure the required power supply before testing. Please take the following operation:

1. Be familiar with the device and its operation.
2. Cut off power supply.
3. Make sure the following items are respected before proceeding:
 - Mechanical operation device shall be convenient for the operation of refrigerant tank;
 - All personal protection apparatuses shall be workable, and they are used correctly;
 - The whole recycle procedure shall be done under the instruction of qualified person;
 - The recycled device and refrigerant tank shall comply with relevant standards.
4. Please arrange vacuum pumping to the refrigeration system. If vacuum status cannot be reached, please arrange vacuum pumping from several positions to recycle the refrigerant in different parts of the system.
5. Make sure the capacity of refrigerant tank is sufficient before recycling.
6. Start and operate the recycled device according to the operation instruction of manufacturer.
7. Make sure the refrigerant tank is not too full (the filled liquid shall not exceed 80% of the capacity of refrigerant tank).
8. Do not exceed the maximum operation pressure.
9. Remove the refrigerant tank and device quickly after finishing operation and make sure all cut-off valves in the device are closed.
10. The recycled refrigerant cannot be filled into another refrigeration system before purification and inspection.

Label:

The unit shall be labeled with data and note after scrapping and discharging refrigerant. Make sure the label on the unit can reflect the R32 refrigerant which it has been filled.

Recycle:

It's recommended to remove the refrigerant from the system before maintenance and disposal.

To recycle, put the refrigerant into the specialized refrigerant tank with refrigerant label. The refrigerant tank shall be equipped with pressure-relief valve and cut-off valve, if they are in good condition. If possible, the empty tank should be dealt with vacuum pumping before using and keep it at normal temperature.

Recycling device shall be kept in good working status and equipped with operation instructions for reference. The device shall be applicable for the recycle of R32 refrigerant. In addition, qualified weighing apparatus which can be used normally shall be prepared. The hose shall adopt removable connector without leakage for connection and keep it in good status. Check if the recycling device is in normal status before using it and if it is properly stored with all electrical components sealed to prevent fire hazard caused by refrigerant leakage. If you have any question, please consult a qualified technician.

The recycled refrigerant shall be put in proper containers attached with transportation instruction and send it back to the refrigerant manufacturer. Do not mix different refrigerants in the refrigerant recycle device, especially the refrigerant tank.

When disassembling the compressor or clearing the compressor oil, make sure the compressor has been dealt with vacuum pumping to suitable level, so that no R32 refrigerant remains in the lubricant. Vacuum pumping shall be done before the compressor is sent back to the supplier. Only electric heating can be adopted for heating the shell of compressor to speed up the course. When oil is drained from the system, please ensure safety.

Additional Information for Maintenance Must be done by a qualified technician

Area Check

Prior to beginning work on systems containing FLAMMABLE REFRIGERANTS, safety checks are necessary to ensure that the risk of ignition is minimised.

General Work Area

- All maintenance staff and others working in the local area shall be instructed on the nature of the work being carried out.
- Work in confined spaces shall be avoided.
- The area around the workspace shall be sectioned off.
- Ensure that the conditions within the area have been made safe by control of flammable material.

Checking for presence of refrigerant

The area shall be checked with an appropriate refrigerant detector prior to and during work, to ensure the technician is aware of potentially toxic or flammable atmospheres. Ensure that the leak detection equipment being used is suitable for use with all applicable refrigerants (i.e. non-sparking, adequately sealed or intrinsically safe).

Presence of fire extinguisher

If any hot work is to be conducted on the refrigeration equipment or any associated parts, appropriate fire extinguishing equipment shall be available to hand. Have a dry powder or CO₂ fire extinguisher adjacent to the charging area.

No ignition sources

All possible ignition sources, including cigarette smoking, should be kept sufficiently far away from the site of installation, repairing, removing and disposal, during which refrigerant can possibly be released to the surrounding space. Prior to work taking place, the area around the equipment is to be surveyed to make sure that there are no flammable hazards or ignition risks. "No Smoking" signs shall be displayed.

Ventilated area

Ensure that the area is in the open or that it is adequately ventilated before breaking into the system or conducting any hot work. A degree of ventilation shall continue during the period that the work is carried out. The ventilation should safely disperse any released refrigerant and preferably expel it externally into the atmosphere.

Checks to the refrigeration equipment

Where electrical components are being changed, they shall be fit for the purpose and to the correct specification. At all times the manufacturer's maintenance and service guidelines shall be followed. If in doubt, consult a qualified technician.

The following checks shall be applied to installations using FLAMMABLE REFRIGERANTS:

- The charge size is in accordance with the room size within which the refrigerant containing parts are installed.
- The ventilation machinery and outlets are operating adequately and are not obstructed.
- If an indirect refrigerating circuit is being used, the secondary circuit shall be checked for the presence of refrigerant.

- Marking to the equipment continues to be visible and legible. Markings and signs that are illegible shall be corrected.
- Refrigeration pipe or components are installed in a position where they are unlikely to be exposed to any substance which may corrode refrigerant containing components, unless the components are constructed of materials which are inherently resistant to being corroded or are suitably protected against being so corroded.

Checks to electrical devices

Repair and maintenance to electrical components shall include initial safety checks and component inspection procedures. If a fault exists that could compromise safety, then no electrical supply shall be connected to the circuit until it is satisfactorily dealt with. If the fault cannot be corrected immediately but it is necessary to continue operation, an adequate temporary solution shall be used. This shall be reported to the owner of the equipment, so all parties are advised.

Initial safety checks shall include:

- Capacitors are discharged: this shall be done in a safe manner to avoid possibility of sparking.
- No live electrical components and wiring are exposed while charging, recovering or purging the system.
- There is continuity of earth bonding.

Repairs to sealed components

During repairs to sealed components, all electrical supplies shall be disconnected from the equipment being worked upon prior to any removal of sealed covers, etc. If it is absolutely necessary to have an electrical supply to equipment during servicing, then a permanently operating form of leak detection shall be located at the most critical point to warn of a potentially hazardous situation. Particular attention shall be paid to the following to ensure that by working on electrical components, the casing is not altered in such a way that the level of protection is affected. This shall include damage to cables, excessive number of connections, terminals not made to original specification, damage to seals, incorrect fitting of glands, etc.

- Ensure that the apparatus is mounted securely.
- Ensure that seals or sealing materials have not degraded to the point that they no longer serve the purpose of preventing the ingress of flammable atmospheres.
- Replacement parts shall be in accordance with the manufacturer's specifications.

Repair to intrinsically safe components

Do not apply any permanent inductive or capacitance loads to the circuit without ensuring that this will not exceed the permissible voltage and current permitted for the equipment in use. Intrinsically safe components are the only types that can be worked on while live in the presence of a flammable atmosphere. The test apparatus shall be at the correct rating. Replace components only with parts specified by the manufacturer. Other parts may result in the ignition of refrigerant in the atmosphere from a leak.

Cabbling

Check that cabling will not be subject to wear, corrosion, excessive pressure, vibration, sharp edges or any other adverse environmental effects. The check shall also consider the effects of aging or continual vibration from sources such as compressors or fans.

Detection of flammable refrigerants

Under no circumstances shall potential sources of ignition be used in the searching for or detection of refrigerant leaks. A halide torch (or any other detector using a naked flame) shall not be used.

Leak detection methods

The following leak detection methods are deemed acceptable for all refrigerant systems:

- Electronic leak detectors may be used to detect refrigerant leaks but, in the case of FLAMMABLE REFRIGERANTS, the sensitivity may not be adequate, or may need re-calibration. Detection equipment shall be calibrated in a refrigerant-free area.
- Ensure that the detector is not a potential source of ignition and is suitable for the refrigerant used. Leak detection equipment shall be set at a percentage of the LFL of the refrigerant and shall be calibrated to the refrigerant employed, and the appropriate percentage of gas (25 % maximum) is confirmed.
- Leak detection fluids are suitable for use with most refrigerants but the use of detergents containing chlorine shall be avoided as the chlorine may react with the refrigerant and corrode the copper pipe-work.

If a leak is suspected, all naked flames shall be removed/extinguished.

If a leakage of refrigerant is found which requires brazing, all the refrigerant shall be recovered from the system, or isolated (by means of shut off valves) in a part of the system remote from the leak.

For appliances containing FLAMMABLE REFRIGERANTS, oxygen free nitrogen (OFN) shall then be purged through the system both before and during the brazing process.

Removal and evacuation

When breaking into the refrigerant circuit to make repairs or for any other purpose, conventional procedures shall be used. However, for flammable refrigerants it is important that the best practice is. Opening of the refrigeration systems shall not be done by brazing. The following procedure shall be adhered to:

1. Remove refrigerant.
2. Purge the circuit with inert gas.
3. Evacuate.
4. Purge again with inert gas.
5. Open the circuit by cutting or brazing.

The refrigerant charge shall be recovered into the correct recovery cylinders. For appliances containing FLAMMABLE REFRIGERANTS, the system shall be "flushed" with OFN to render the unit safe. This process may need to be repeated several times. Compressed air or oxygen shall not be used for purging refrigerant systems.

For appliances containing FLAMMABLE REFRIGERANTS, flushing shall be achieved by breaking the vacuum in the system with OFN and continuing to fill until the working pressure is achieved, then venting to atmosphere, and finally pulling down to a vacuum. This process shall be repeated until no refrigerant is found within the system. When the final OFN charge is used, the system shall be vented down to atmospheric pressure to enable work to take place. This operation is vital if brazing operations on the pipework are to take place.

Ensure that the outlet for the vacuum pump is not close to any ignition sources and that ventilation is available.

Charging procedures

In addition to conventional charging procedures, the following requirements shall be followed:

- Ensure that contamination of different refrigerants does not occur when using charging equipment. Hoses or lines shall be as short as possible to minimise the amount of refrigerant contained in them.
- Cylinders shall be kept upright.
- Ensure that the refrigeration system is earthed prior to charging the system with refrigerant.
- Label the system when charging is complete (if not already).
- Extreme care shall be taken not to overfill the refrigeration system.
- Prior to recharging the system, it shall be pressure-tested with the appropriate purging gas. The system shall be leak-tested on completion of charging but prior to commissioning.
- A follow up leak test shall be carried out prior to leaving the site.

Decommissioning

Before carrying out this procedure, it is essential that the technician is completely familiar with the equipment and all its detail. It is recommended good practice that all refrigerants are recovered safely.

Prior to the task being carried out, an oil and refrigerant sample shall be taken in case analysis is required prior to re-use of reclaimed refrigerant. It is essential that electrical power is available before the task is commenced.

1. Become familiar with the equipment and its operation.
2. Isolate system electrically.
3. Before attempting the procedure, ensure that:
 - Mechanical handling equipment is available.
 - All personal protective equipment is available and being used correctly.
 - The recovery process is always supervised by a competent person.
 - The recovery equipment and cylinders conform to the appropriate standards.
4. Pump down refrigerant system, if possible.
5. If a vacuum is not possible, make a manifold so that refrigerant can be removed from various parts of the system.
6. Make sure that cylinder is situated on the scales before recovery takes place.
7. Start the recovery machine and operate in accordance with manufacturer's instructions.
8. Do not overfill cylinders. (No more than 80 % volume liquid charge).
9. Do not exceed the maximum working pressure of the cylinder, even temporarily.
10. When the cylinders have been filled correctly and the process completed, make sure that the cylinders and the equipment are removed from site promptly and all isolation valves on the equipment are closed off.
11. Recovered refrigerant shall not be charged into another refrigeration system unless it has been cleaned and checked.

Labelling

Equipment shall be labelled stating that it has been decommissioned and emptied of refrigerant. The label shall be dated and signed. For appliances containing FLAMMABLE REFRIGERANTS, ensure that there are labels on the equipment stating the equipment contains flammable refrigerant.

Recovery

- When removing refrigerant from a system, either for servicing or decommissioning, it is recommended good practice that all refrigerants are removed safely.
- When transferring refrigerant into cylinders, ensure that only appropriate refrigerant recovery cylinders are employed. Ensure that the correct number of cylinders for holding the total system charge are available.
- All cylinders to be used are designated for the recovered refrigerant and labelled for that refrigerant.
- Cylinders shall be complete with pressure-relief valve and associated shut-off valves in good working order.
- Empty recovery cylinders are evacuated and, if possible, cooled before recovery occurs.
- The recovery equipment shall be in good working order with a set of instructions concerning the equipment that is at hand and shall be suitable for the recovery of all appropriate refrigerants including, when applicable, FLAMMABLE REFRIGERANTS.
- A set of calibrated weighing scales shall be available and in good working order.
- Hoses shall be complete with leak-free disconnect couplings and in good condition.
- Before using the recovery machine, check that it is in satisfactory working order, has been properly maintained and that any associated electrical components are sealed to prevent ignition in the event of a refrigerant release. Consult manufacturer if in doubt.
- The recovered refrigerant shall be returned to the refrigerant supplier in the correct recovery cylinder, and the relevant waste transfer note arranged. Do not mix refrigerants in recovery units and especially not in cylinders.
- If compressors or compressor oils are to be removed, ensure that they have been evacuated to an acceptable level to make certain that flammable refrigerant does not remain within the lubricant. The evacuation process shall be carried out prior to returning the compressor to the suppliers. Only electric heating to the compressor body shall be employed to accelerate this process. When oil is drained from a system, it shall be carried out safely.

MALFUNCTION ANALYSIS

Malfunction code:

When an abnormal phenomenon occurs with the air conditioner, the screen displays a malfunction code:

Code	Solution
F0	Please contact professional person to deal with it.
F1	Please contact professional person to deal with it.
F2	Please contact professional person to deal with it.
F4	Please contact professional person to deal with it.
E8	Please contact professional person to deal with it.
H3	Please contact professional person to deal with it.





WARNING

- If any of the following phenomena is observed, please turn off the air conditioner and disconnect the device immediately. Once this step is completed, call your retailer.
 - The power wire is overheated or damaged.
 - There is an abnormal sound during the operation of the machine.
 - There is a burning smell.
 - The "reset" button on the power cord comes out automatically.
 - There is water infiltration inside.
- Do not repair or readjust the air conditioner by yourself.
- Operating the air conditioner under abnormal circumstances will cause malfunction, electric shock or fire.

You can solve many common air conditioner problems easily, saving you the cost of a service call. Try the suggestions below to see whether you can solve your problem without needing to use outside help.

Issue	Possible Causes	Solution
Air conditioner will not operate.	The power supply cord is unplugged.	Plug into grounded 3 prong outlet.
	There is a power failure.	Wait after power recovery.
	The power supply cord trips (Reset button will pop out).	Press and release RESET (listen for click; Reset button will latch and on some devices, a green light will turn on) to resume operation. See below for more details.
	A household fuse has blown, or circuit breaker has tripped.	Replace the fuse or reset the circuit breaker. See below for more details.
	Depending on model, the Power button has not been pressed or the Fan Speed control is turned to Off.	Press POWER button or turn the FAN SPEED control to an active setting.
	The local power has failed.	Wait for power to be restored.
Air conditioner blows fuses or trips circuit breakers.	Too many appliances are being used on the same circuit.	Unplug or relocate appliances that share the same circuit.
	Time-delay fuse or circuit breaker of the wrong capacity is being used.	Replace with a time-delay fuse or circuit breaker of the correct capacity.
	An extension cord is being used.	Do not use an extension cord with this or any other appliance.
	You are trying to restart the air conditioner too soon after turning the unit off.	Wait at least 3 minutes after turning the unit off before trying to restart the air conditioner.
Air conditioner power supply cord trips (Reset button pops out).	Disturbances in your electrical current can trip (Reset button will pop out) the power supply cord.	Press and release RESET (listen for click; Reset button will latch and on some devices, a green light will turn on) to resume operation.
	An electrical overloading, overheating, pinching or aging can trip (Reset button will pop out) the power supply cord .	After correcting the problem, press and release RESET (listen for click; Reset button will latch and on some devices, a green light will turn on) to resume operation.
	NOTE: A damaged power supply cord must be replaced with a new power supply cord obtained from the product manufacturer. A damaged power supply cord must not be repaired.	
Temperature can't be adjusted	Is the temperature operating under auto or fan mode?	The temperature cannot be adjusted under auto or fan mode
	Does the required temperature exceeds the allowed temperature interval?	The temperature can only be adjusted between 61°F (16°C) and 86°F (30°C)
There is an odour	There's a source of odour in the room such as furniture, cigarettes, etc.	Eliminate odour source.
		Clean filter

Issue	Possible Causes	Solution
Air conditioner seems to run too much.	The current air conditioner replaced an older model.	The use of more efficient components may cause the air conditioner to run longer than an older model, but the total energy consumption will be less. Newer air conditioners do not emit the “blast” of cold air you may be accustomed to from older units, but this is not an indication of lesser cooling capacity or efficiency. Refer to the efficiency rating (EER) and capacity rating (in BTU/hr.) marked on the air conditioner.
	The air conditioner is in a heavily occupied room, or heat producing appliances are in use in the room.	Use exhaust vent fans while cooking or bathing and try not to use heat producing appliances during the hottest part of the day. A higher capacity air conditioner may be required, depending on the size of the room being cooled.
Water drips from cabinet into your house.	The air conditioner is not properly leveled.	The air conditioner should slope slightly downward toward the outside. Level the air conditioner to provide a downward slope toward the outside to ensure proper drainage. See the Installation Instructions.
	NOTE: Do not drill a hole in the bottom of the metal base and condensate pan.	
Air conditioner can't receive signal from remote controller or remote controller is not sensible.	The unit is interfered seriously (such as static pressure, unstable voltage).	Please pull out the plug. Insert the plug after about 3 minutes, and then turn on the unit.
	Remote controller is not within the receiving range.	The receiving range of remote controller is 8 m (26.25'). Do not exceed this range.
	It's blocked by obstacles.	Remove the obstacles
	Sensitivity of remote controller low.	Check the batteries of remote controller. If the power is low, please replace the batteries.
	There's a fluorescence lamp in the room.	Move the remote controller close to the air conditioner. Turn off lamp and try it again.
There is an abnormal sound when operation is working	Could there be an interference such as radio, thunder, etc.?	Turn the appliance off, disconnect it, re-connect it and turn it on.

Issue	Possible Causes	Solution
Air conditioner cycles on and off too much or does not cool.	The Mode is set to Power Saver (on some models).	Use Power Saver only when you are away from home or asleep, since the fan does not circulate the room air continuously. Use Low, High or Turbo for your best comfort.
	The air conditioner is not properly sized for your room.	Check the cooling capabilities of your room air conditioner. Room air conditioners are not designed to cool multiple rooms.
	The filter is dirty or obstructed by debris.	Clean the filter.
	The inside evaporator and outside condenser coils are dirty or obstructed by debris.	See "Annual Maintenance" in the cleaning and maintenance section.
	There is excessive heat or moisture (open container cooking, showers, etc.) in the room.	Use a fan to exhaust heat or moisture from the room. Try not to use heat producing appliances during the hottest part of the day.
	The louvers are blocked.	Install the air conditioner in a location where the louvers are free from curtains, blinds, furniture, etc.
	The outside temperature is below 65 °F (18°C).	Do not try to operate your air conditioner in the cooling mode when the outside temperature is below 65°F (18°C).
	The temperature of the room you are trying to cool is extremely hot.	Allow extra time for the air conditioner to cool off a very hot room.
	Windows or doors to the outside are open.	Close all windows and doors.
	The Exhaust control is set to OPEN (on some models).	Push the Exhaust control CLOSED for maximum cooling.
	Depending on model, the  /  or  control is not at a cool enough setting.	Adjust the  /  control to a cooler setting by pressing the minus button to reduce the temperature or adjust the TEMPERATURE control to a cooler setting by turning the knob clockwise. Set the FAN SPEED control to highest setting (Turbo or High, depending on model).
You can hear the sound of water circling	Is the appliance on or did you just turn it off?	This is a normal sound. It is simply the sound of the refrigerant circling through the machine.
You can hear a friction or a knocking sound	Is the appliance on or did you just turn it off?	The appliance internal panel is expanding or shrinking according to the temperatures changes, which causes a sound of friction.

ASSISTANCE

Distributed by Ouellet Canada Inc.
1 877 247-3461

Before returning the unit to the retailer, for any problem related to the installation, use or proper functioning of the unit; contact our customer support department. One of our agents will guide you through the next steps.

Products have a limited warranty of one year upon presentation of proof of purchase.

Before calling for assistance or service, please check the troubleshooting section. It may save you the cost of a service call.

If you still need help, follow the instructions below. Please know the location and purchase date of your product. Please have in hand the complete model and serial number of your appliance. This information will help us to better respond to your request.

Please record the model and serial number information below. Also, make sure you keep the purchase invoice of your product.

Model Number _____

Serial Number _____

Purchase Date _____

Store Name _____