



PORTABLE AIR CONDITIONER

PAT Series

OWNER'S MANUAL
OPERATOR'S MANUAL
TECHNICAL MANUAL

For models:

GPC04AP-A6NNA1A

GPC05AP-A6NNA1A

GPC06AP-A6NNA1A

*Please read this owner's manual carefully
before operating the unit and keep it for future reference.*



IMPORTANT : The remote control and hardware necessary to use your new product is included inside the box. You will find them inserted in the Styrofoam included in the box.

TABLE OF CONTENTS

Operation Notices	3
Safety Warnings	3
Exception Clauses	3
The Refrigerant.....	4
Safety precautions	5
Operation environment.....	6
Parts name	7
Operation Guide	8
Open the guide louver	8
Operation introduction for control panel.....	8
Buttons on remote controller	10
Maintenance	11
Clean and maintenance	11
Installation	13
Installation precaution	13
Preparation for installation	14
Install cord hooks	14
Removing collected water	15
Installation of heat discharge pipe	16
Install window panel	17
Malfunction analysis	19
Annex	21
Operation test.....	21
Electric schematic diagram.....	21
Specialist's manual.....	22
Assistance	28

OPERATION NOTICES

Safety warnings

- | | |
|---|---|
|  WARNING | This symbol indicates the possibility of death or serious injury. |
|  CAUTION | This symbol indicates the possibility of injury or damage to property. |
| NOTICE | Indicates important but not hazard-related information, used to indicate risk of property damage. |

Exception Clauses

Manufacturer will bear no responsibilities when personal injury or property loss is caused by the following reasons.

1. Damage the product due to improper use or misuse of the product;
2. Alter, change, maintain or use the product with other equipment without abiding by the instruction manual of manufacturer;
3. After verification, the defect of product is directly caused by corrosive gas;
4. After verification, the defects are due to improper operation during transportation of product;
5. Operate, repair, maintain the unit without abiding by instruction manual or related regulations;
6. After verification, the problem or dispute is caused by the quality specification or performance of parts and components that produced by other manufacturers;
7. The damage is caused by natural calamities, bad using environment or force majeure.

If it needs to install, move or maintain the air conditioner, please contact dealer or local service center to conduct it at first. Air conditioner must be installed, moved or maintained by appointed unit. Otherwise, it may cause serious damage or personal injury or death.

When refrigerant leaks or requires discharge during installation, maintenance, or disassembly, it should be handled by certified professionals or otherwise in compliance with local laws and regulations.

This appliance is not intended for use by persons (including children) with reduced physical, sensory or mental capabilities or lack of experience and knowledge, unless they have been given supervision or instruction concerning use of the appliance by a person responsible for their safety.

Children should be supervised to ensure that they do not play with the appliance.

The refrigerant



A2L Appliance filled with flammable gas R32.



Before use the appliance, read the owner's manual first.



Before install the appliance, read the installation manual first.



Before repair the appliance, read the service manual first.

To realize the function of the air conditioner unit, a special refrigerant circulates in the system. The used refrigerant is the fluoride R32, which is specially cleaned. The refrigerant is flammable and inodorous. Furthermore, it can lead to explosion under certain conditions. But the flammability of the refrigerant is very low. It can be ignited only by fire.

Compared to common refrigerants, R32 is a nonpolluting refrigerant with no harm to the ozone-sphere. The influence upon the greenhouse effect is also lower. R32 has got very good thermodynamic features which lead to a really high energy efficiency. The units there fore need a less filling.

WARNING

- Appliance filled with flammable gas R32
- Appliance shall be installed, operated and stored in a room with a floor area larger than 4m² (43.06 ft²).
- The appliance shall be stored in a room without continuously operating ignition sources. (for example: open flames, an operating gas appliance or an operating electric heater.)
- The appliance shall be stored in a well-ventilated area where the room size corresponds to the room area as specified for operation.
- The appliance shall be stored so as to prevent mechanical damage from occurring.
- Ducts connected to an appliance shall not contain an ignition source.
- Keep any required ventilation openings clear of obstruction.
- Do not pierce or burn.
- Be aware that refrigerants may not contain an odour.
- Do not use means to accelerate the defrosting process or to clean, other than those recommended by the manufacturer.
- Servicing shall be performed only as recommended by the manufacturer.
- Should repair be necessary, contact your nearest authorized Service Centre. Any repairs carried out by unqualified personnel may be dangerous.
- Compliance with national gas regulations shall be observed.
- Read specialist's manual.



A2L



Safety precautions



- This appliance can be used by children aged from 8 years and above and persons with reduced physical, sensory or mental capabilities or lack of experience and knowledge if they have been given supervision or instruction concerning use of the appliance in a safe way and understand the hazards involved.
- Children shall not play with the appliance.
- Cleaning and user maintenance shall not be made by children without supervision.
- Before operation, please confirm whether power specification complies with that on name-plate.
- Before cleaning or maintaining the air conditioner, please turn off air conditioner and pull out the power plug.
- Make sure the power cord hasn't been pressed by hard objects.
- Do not pull or drag the power cord to pull out the power plug or move the air conditioner.
- Do not insert or pull out the power plug with wet hands.
- Please use the grounded power. Make sure the grounding is reliable.
- If the supply cord is damaged, it must be replaced by the manufacturer or its service agent or a similarly qualified person in order to avoid a hazard.
- If abnormal condition occurs (e.g. burned smell), please disconnect power at once and then contact local dealer.
- When nobody is taking care of the unit, please turn it off and remove the power plug or disconnect power.
- Do not splash or pour water on air conditioner. Otherwise, it may cause short circuit or damage to air conditioner.
- If drainage hose is used, ambient temperature can't be lower than 0°C (32°F).
- Otherwise, it will cause water leakage to air conditioner.
- Prohibit operating heating equipment around the air conditioner.
- Prohibit operating the unit in the bathroom or laundry room.
- Far away from fire source, inflammable and explosive objects.
- Children and disabled people are not allowed to use the portable room air conditioner without supervision.
- Keep children from playing or climbing on the air conditioner.
- Do not put or hang dripping objects above the air conditioner.
- Do not repair or disassemble the air conditioner by yourself.
- Prohibit inserting any objects into the air conditioner.
- Do not through sundries into the air duct. If there are sundries get into the air duct, please contact the professionals to deal with it.
- Do not use an extension cord.
- Specification of fuse on the main board: T3.15AH250V; the maximum current passes through the fuse can't be more than 3.15A.
- The appliance shall be installed in accordance with national wiring regulations.
- Do not mix old and new batteries.

Operation environment

- Operating Temperature Range
Maximum cooling: DB/WB(°F/°C), 95/75(35/24)
The air conditioner must be operated within the temperature range: 61°F (16°C)~95°F (35°C).
- The appliance is for indoor use only.
- The appliance must be positioned so that the plug is accessible.
- This air conditioner can only be used for family, not for commercial industry.
- Reserved space around the air conditioner should be 30 cm (12") at least.
- Do not operate the air conditioner at humid environment.
- Please keep air inlet and air outlet clean, no obstacles.
- During operation, close doors and windows to improve cooling effect.
- Please put the air conditioner at smooth and flat ground for operation to avoid noise and vibration.
- This air conditioner is equipped with castors. Castors should slide at smooth and flat ground.
- Prohibit inclining or turning over the air conditioner. If there's abnormality, please disconnect power immediately and contact dealer.
- Avoid direct sunshine.

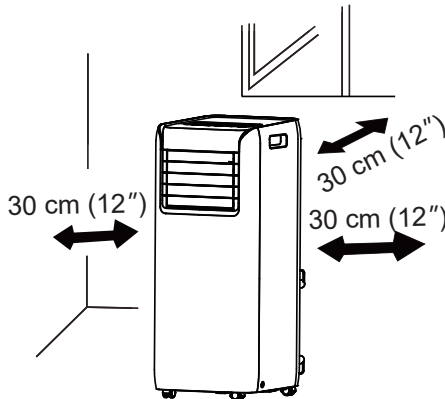

Parts name

NOTICE: Actual product may be different from graphics, please refer to actual products.
Installation accessories can't be discarded.

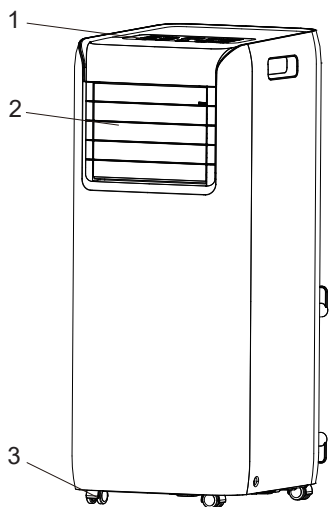

1. Controller panel
2. Guide louver
3. Castor
4. Filter
5. Joint
6. Heat discharge pipe
7. Rear clip
8. Power cord
9. Cord hook

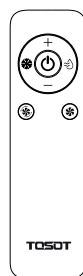
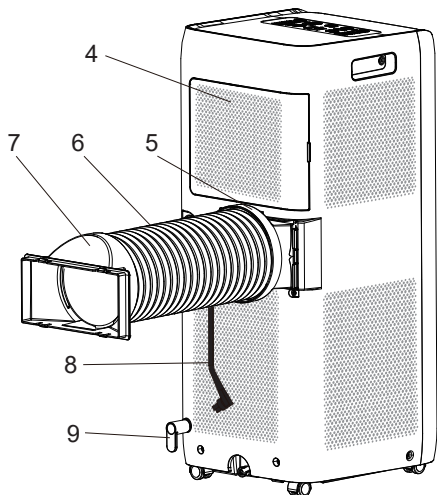

Remote controller

OPERATION GUIDE

Open the guide louver

Press the position marked with "PUSH" on the guide louver with fingers to open the guide louver before use the unit.

In order to improve the comfort, you are suggested to open the air guide louver to the maximum position for operation.

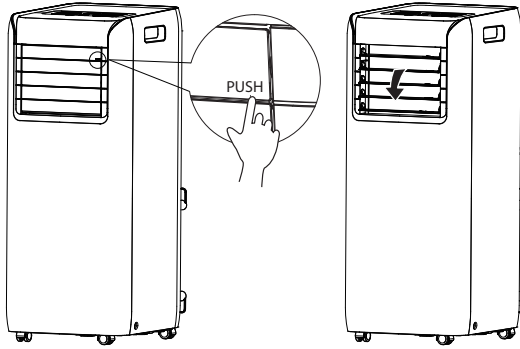

Operation introduction for control panel

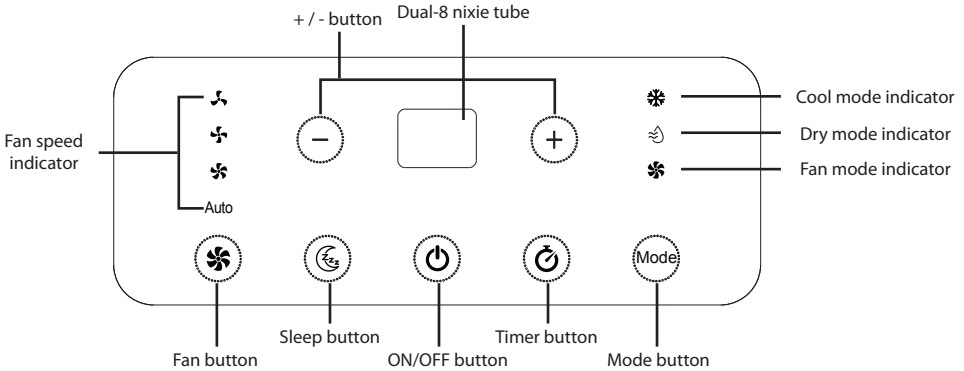

NOTE:

- After putting through the power, the air conditioner will give out a sound. After that, you can operate the air conditioner by the control panel.
- Under ON status, after each pressing of the button on control panel, the air conditioner will give out a sound. Meanwhile, corresponding indicator on control panel will be bright.
- Under OFF status, dual-8 nixie tube on control panel won't display. Under ON status, dual-8 nixie tube on control panel will display set temperature under cooling mode and Heating mode (Coo l& Heat Unit only), while it won't display under other modes.

Operation of control panel

1 ON/OFF BUTTON

Pressing this button can turn on or turn off the air conditioner.

2 + / - BUTTON

Under cooling mode, press "+" or "-" button to increase or decrease set temperature by 1°F (°C). Set temperature range is 61°F (16°C)~86°F (30°C). Under dry or fan mode, this button is invalid.

3 FAN BUTTON

Press this button and the fan speed will circulate as :

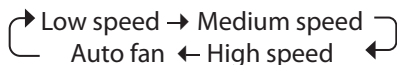

4 MODE BUTTON

Press this button and the mode will circulate as:

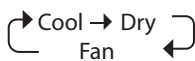

Cool: Under this mode, cool mode indicator is bright. Dual-8 nixie tube displays set temperature. Temperature setting range is 61°F (16°C)~86°F (30°C).

Dry: Under this mode, dry mode indicator is bright. Dual-8 nixie tube won't display. Low speed only under this model.

Fan: Under this mode, the air conditioner only blow fan. Fan mode indicator is bright. Dual-8 nixie tube won't display.

5 TIMER BUTTON

Press this button and the mode will circulate according to below sequence:

Press timer button to enter into timer setting mode. Under this mode, press "+" or "-" button to adjust the timer setting. Timer setting will increase or decrease 0.5 hour by pressing "+" or "-" button within 10 hours, while timer setting will increase or decrease 1 hour by pressing "+" or "-" button beyond 10 hours. After timer setting is finished, the unit will display temperature if there's no operation for 5 seconds. If timer function is started up, the upper indicator will keep the display status. Others, it won't be displayed. Under timer mode, press timer button again to cancel timer mode.

6 SLEEP BUTTON

Only the "Cool Mode" can be used under this mode.

Press sleep button to enter into sleep mode. If the controller operates at cooling mode, after sleep mode is started up, preset temperature will increase by 2°F (1°C) within 1 hour; preset temperature will increase by 4°F (2°C) within 2 hours and then the unit will operate at this temperature all the time; Sleep function is not available for fan mode, drying mode. If sleep function is started up, the upper indicator will keep the display status. The other icons, will not be displayed.

Buttons on remote controller

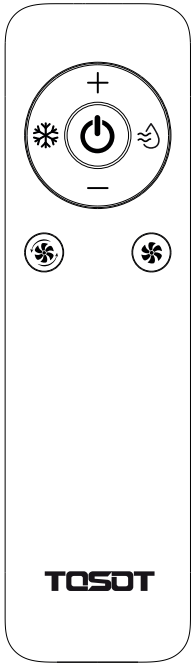

ON/OFF BUTTON

Press this button to turn on or turn off the air conditioner.

+ / - BUTTON

Press "+" or "-" button once to increase or decrease set temperature by 1°F (°C).

COOL BUTTON

Press this button and then the air conditioner will operate in cool mode.

DRY BUTTON

Press this button and then the air conditioner will operate in dry mode.

FAN ONLY BUTTON

Press this button and then the air conditioner will operate in fan mode. It only blows wind, no cooling.

FAN SPEED BUTTON

Press this button to set the fan speed at Auto, Low, Med or High.

NOTE: Only low fan speed is available under Dry mode.

Replacement of batteries in remote controller

1. Press the back side of remote controller marked with "=" as shown in the fig, and then push out the cover of battery box along the arrow direction.
2. Replace two 7# (AAA 1.5V) dry batteries, and make sure the position of "+" polar and "-" polar are correct.
3. Reinstall the cover of battery box.

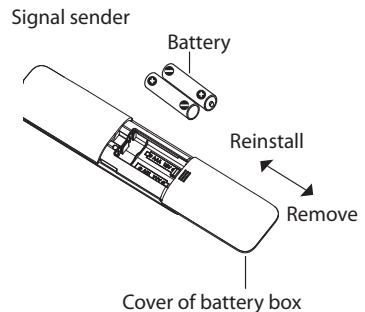

NOTICE

- During operation, point the remote control signal sender at the receiving window on indoor unit.
- The distance between signal sender and receiving window should be no more than 8m (26.25'), and there should be no obstacles between them.
- Signal may be interfered easily in the room where there is fluorescent lamp or wireless telephone; remote controller should be close to indoor unit during operation.
- Replace new batteries of the same model when replacement is required.
- When you don't use remote controller for a long time, please take out the batteries.
- If the display on remote controller is fuzzy or there's no display, please replace batteries.
- Do not mix alkaline, standard (carbon-zinc) or rechargeable (ni-cad, ni-mh, etc.) batteries.

MAINTENANCE

Clean and maintenance

WARNING

- Before cleaning the air conditioner, please turn off the unit and disconnect power. Otherwise, it may cause electric shock.
- Do not wash air conditioner with water. Otherwise, it may cause electric shock.
- Do not use volatile liquid (such as thinner or gas) to clean the air conditioner. Otherwise, it may damage the appearance of air conditioner.
- Do not use liquid or corrosive detergent clean the appliance and do not splash water or other liquid onto it, otherwise, it may damage the plastic components, even cause electric shock.

Clean outer case and grille

Clean outer case: If there's dust on the surface of outer case, please use soft towel to wipe it. If the outer case is very dirty (such as grease), please use neutral abluent to wipe it.

Clean grille: Use cleaner or soft brush to clean it.

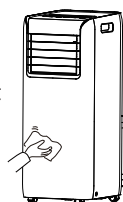

Clean filter

1. Remove the filter
Press the clasp as shown in the fig, and then remove the filter ;

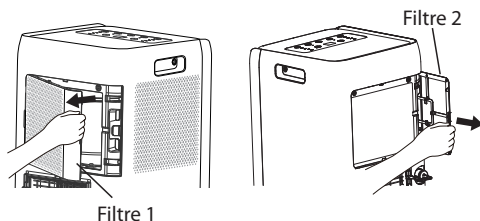

2. Clean filter

Use cleaner or water to clean the filter. If the filter is very dirty (such as grease), use warm water 104°F (40°C) melted with neutral abluent to clean it and put at shady place to dry it.

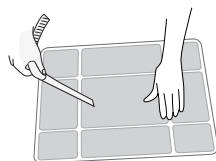

3. Install filter

After the filter is cleaned and dried, reinstall it well.

NOTICE

- The filter should be cleaned about once every three months. If there's much dust in the operation environment, you can increase clean frequency.
- Do not dry the filter with fire or hair drier. Otherwise, it may be deformed or catch fire.

Clean heat discharge pipe

Remove the heat discharge pipe from air conditioner, clean and dry it , and then reinstall it. (For the method of installation and removal, please refer to the instruction for "Installation of heat discharge pipe").

Checking before use-season

1. Check whether air inlets and air outlets are blocked.
2. Check whether plug and socket are in good condition.
3. Check whether filter is clean.
4. Check whether batteries are installed in remote controller.
5. Check whether joint, window bracket and heat discharge pipe are installed tightly.
6. Check whether heat discharge pipe is damaged.

Checking after use-season

1. Disconnect power supply.
2. Clean filter and outer case.
3. Remove dust and sundries on the air conditioner.
4. Eliminate accumulated water in chassis (refer to the section of "Removing collected water" for details).
5. Check whether window bracket is damaged or not. If yes, please contact dealer.

Long-time storage

If you don't use the air conditioner for a long time, please maintain it by following steps for good performance:

- Make sure there's no accumulated water in chassis and the heat discharge pipe is disassembled.
- Pull out the plug and wrap the power cord.
- Clean the air conditioner and pack it well to prevent dust.

Notice for recovery

- Many packing materials are recyclable materials. Please deal with them through local recycle bin.
- If you want to throw away the air conditioner, please contact local division or consultant service center for the correct disposal method.

INSTALLATION

Installation precaution

WARNING

- Observe all governing codes and ordinances.
- Do not use damaged or non-standard power cord.
- Be caution during installation and maintenance. Prohibit incorrect operation to prevent electric shock, casualty and other accidents.

Selection of installation location

Basic requirement

Installing the unit in the following places may cause malfunction. If it is unavoidable, please consult the local dealer:

1. The place with strong heat sources, vapors, flammable or explosive gas, or volatile objects spread in the air.
2. The place with high-frequency devices (such as welding machine, medical equipment).
3. The place near coast area.
4. The place with oil or fumes in the air.
5. The place with sulfureted gas.
6. Other places with special circumstances.
7. It's not allowed to be installed on the unstable or motive base structure (such as truck) or in the corrosive environment (such as chemical factory).

Requirement of air conditioner

1. Air inlet should be far away from obstacles and do not put any objects near air outlet. Otherwise, it will affect the radiation of heat discharge pipe.
2. Select a location where the noise and outflow air emitted by the outdoor unit will not affect neighborhood.
3. Please try your best to keep far away from fluorescent lamp.
4. The appliance shall not be installed in the laundry.

Requirements for electric connection

Safety precaution







1. Must follow the electric safety regulations when installing the unit.
2. According to the local safety regulations, use qualified power supply circuit.
3. For appliances with type Y attachment, the instructions shall contain the substance of the following. If the supply cord is damaged, it must be replaced by the manufacturer, its service agent or similarly qualified persons in order to avoid a hazard.
4. Properly connect the live wire, neutral wire and grounding wire of power socket.
5. Be sure to cut off the power supply before proceeding any work related to electricity and safety.
6. Do not put through the power before finishing installation.
7. The air conditioner is first class electric appliance. It must be properly grounding with specialized grounding device by a professional. Please make sure it is always grounded effectively, otherwise it may cause electric shock.
8. The yellow-green wire or green wire in air conditioner is grounding wire, which can't be used for other purposes.
9. The grounding resistance should comply with national electric safety regulations.

Preparation for installation

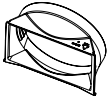
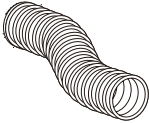
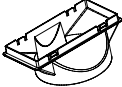
NOTE: Check if the accessories are available before installation.

Please refer to the window panel installation section for the list of these specific accessories.

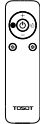
Accessory list

Joint		Heat discharge pipe	
Rear clip		Cord hook	
Screws		User's manual	
Remote controller		Battery (AAA 1.5V)	

Install cord hooks

1. Install the cord hooks at the back of the unit with 2 screws. The top cord hook should face upward, and the bottom cord hook should face downward.
2. Wind the cord around the cord hooks.

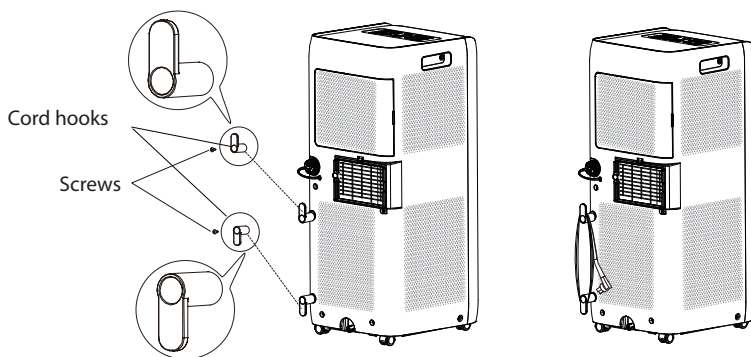

Removing collected water

There are 2 ways to remove collected water: the middle hole or the lower hole.

During Cool mode or Auto mode, it is not recommended to remove the collected water, for improve the performance and save energy.

During Dry mode, it is recommended to use the middle hole to drain outlet.

1. Use the drainage option from the lower hole

When the chassis is full with water, the buzzer will give out 8 sounds and "H8" is displayed to remind user to discharge water:

1. Move the unit to a suitable place for discharging water; do not tilt the unit and keep it horizontal during moving;
2. Take the drainage pipe from the clip and pull out the rubber plug on the drainage pipe to discharge water;
3. Put back the rubber plug onto drainage pipe after finishing discharging water and then fix the pipe on the clip;
4. After full water protection is eliminated and the compressor has been stopped for 3 minutes, the unit will resume operation.

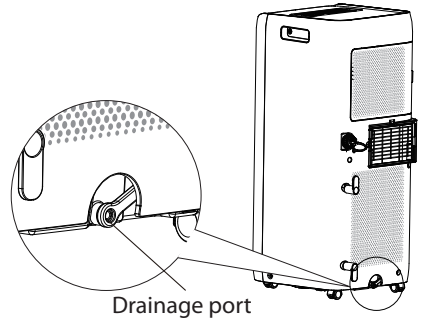

2. Use the continuous drainage option from the middle hole

NOTE : Water can be automatically emptied into a floor drain by attaching 13.5 mm (17/32") inner diameter hose or garden hose (not included).

1. Remove the continuous drain cap by turning it counter clockwise then remove the rubber plug from the spout.

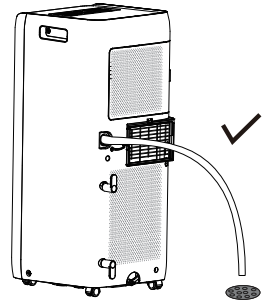
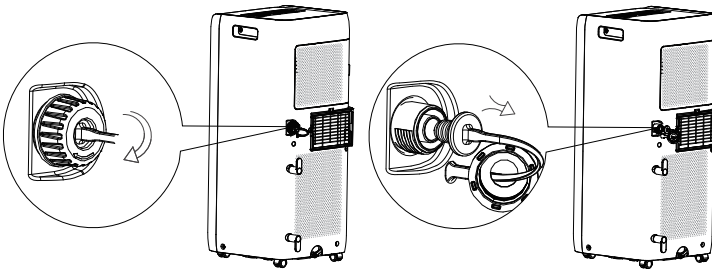

2. Insert the drainage hose into drain connector.

ATTENTION: When using continuous drainage option from the middle hole, place unit on a level surface and make sure hose or garden hose is clear of any obstructions and is directed downward. Placing unit on an uneven surface or improper hose installation may result in water filling up the chassis and causing the unit to shut off. Empty water in the chassis if shut off occurs, then check unit location and hose for proper setup.

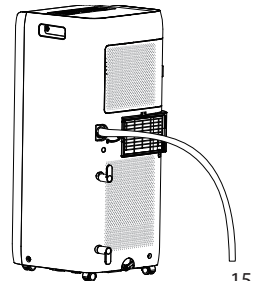

Installation of heat discharge pipe

Install heat discharge pipe

1. Rotate joint and rear clip clockwise into the two ends of heat discharge pipe.

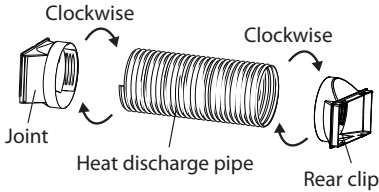

2. Insert joint of heat discharge pipe into the groove until you hear a sound.

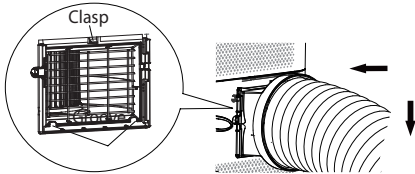

3. Lead the heat discharge pipe outdoors.

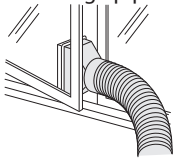

4. Slide and open the exhaust cover on the window panel, and attach the rear clip. (Optional)

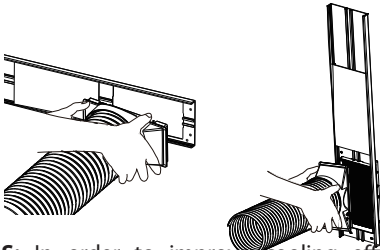

NOTES: In order to improve cooling efficiency, the heat discharge pipe should be as short as possible and flat without curve to ensure smooth heat discharge.

The discharge pipe is suggested to be installed according to below figure by the manufacturer.

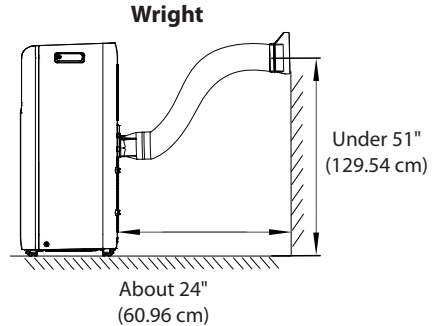

User can adjust the installation method of the discharge pipe basing on the requirement, while the similar installation methods as below which will lead to unsmoothly air-out are not allowed.

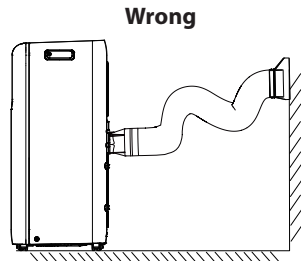



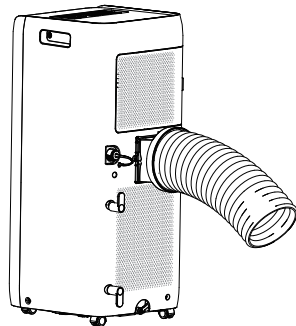









- The length of the heat discharge pipe is less than 40" (101.6 cm). It is recommended to use it with shortest length.
- When installing, heat discharge pipe should be as flat as possible. Don't prolong the pipe or connect it with other heat discharge pipe.

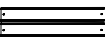

INSTALL WINDOW PANEL

Accessory list

Adjustment panel		Mothproof net		Mounting plate		Screw	
Window panel		Bracket		Rain guard			
Extension panel		Fixed base		Foam seal A			
Exhaust cover		Fixed clip		Foam seal B (adhesive type)			

Suggested tools for installation

1. Screwdriver (medium size Phillips)
2. Tape measure or ruler
3. Knife or scissors
4. Saw (In the event that the window panel needs to be cut down in size because the window is too narrow for direct installation.)

Install window panel

1. Open the window and measure the width or height inside the window frame. Cut the Foam seal B to the proper length and attach it to your horizontal(or verical) sliding window.

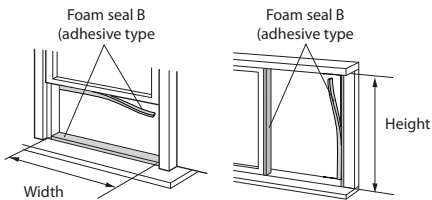

2. Attach the Mothproof net to the back side of the Window Panel. Push the Mothproof net securely into the Window Panel to ensure that is firmly installed.

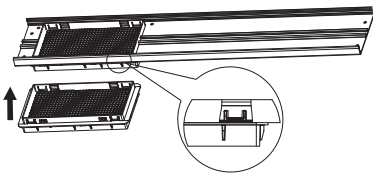

3. Insert the Exhaust cover to the Window Panel.

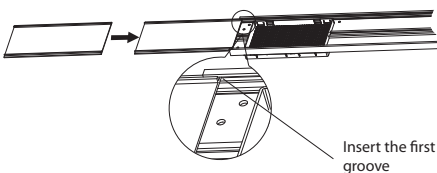

4. Push the fixed base to the end of Window Panel.

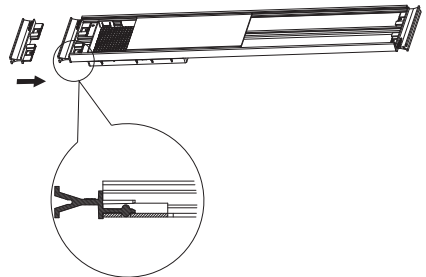

5. Connect the rain guards to the Mothproof net. Insert all three projections on each rain guard into the holes in the Mothproof net. Side "A" will now be at the top, as indicated in the diagram.

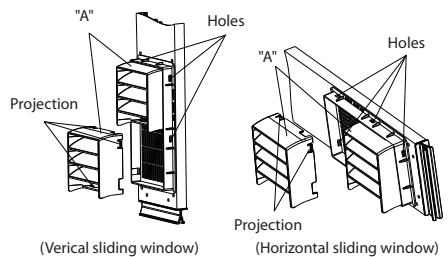

6. The window panel adapts to different window sizes that open horizontally or vertically.

- 6.1 For the window is too narrow for direct installation, The window panel needs to be cut down in size.
 - 6.2 If the width of window is larger than the length of window panel, please use the adjustment panel to make sure you can span the entire length of your window.
 - 6.3 Otherwise, you can add an extension panel to prolong the length of the windows panel assembly.
7. Push fixed base to the end of Window Panel assembly.
After the length is set, secure the panels with a fixed clip and mounting plate.
For certain windows, such as a casement window, you will need to improvise several steps of the installation.

NOTE: Insert the fixed clip into the groove of the adjustment panel and screw down the mounting plates.

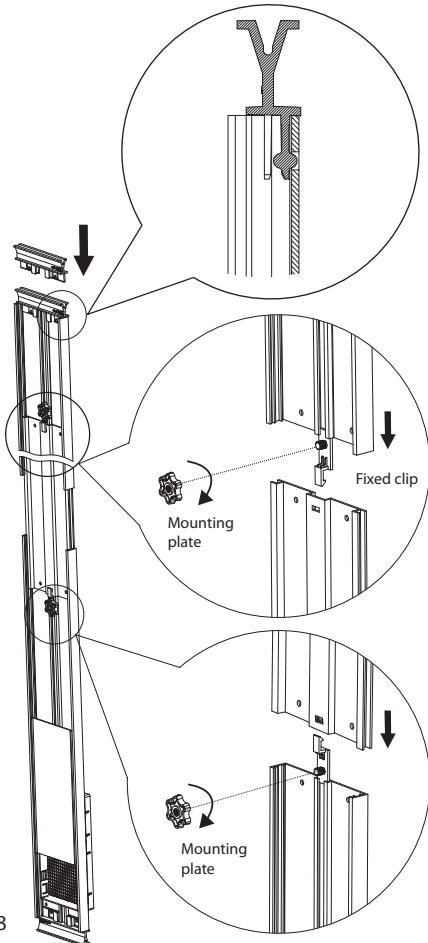

8. Install the window panel into the window frame. Make sure that the exhaust cover is attached to the window panel.

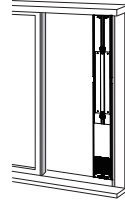

9. Close the window sash securely against the window panel.

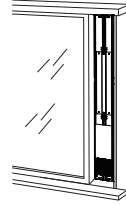

10. Stuff the foam seal A between the glass and the window to prevent air and insects from getting into the room.



11. Attach the bracket with a screw.
(Recommended)

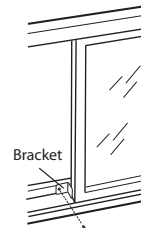

12. Slide and open the exhaust cover on the window panel, and install the Rear clip.

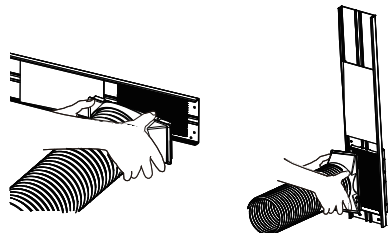

MALFUNCTION ANALYSIS

Please check below items before asking for maintenance. If the malfunction still can't be eliminated, please contact local dealer or qualified professionals.

Issue	Possible Causes	Solution
Air conditioner can't operate	Power failure?	Wait after power recovery.
	Is plug loose?	Reinsert the plug.
	Whether the air switch is tripped off or fuse is burnt?	Ask professional person to replace air switch or fuse.
	Is there malfunction for the circuit?	Ask professional person to replace circuit.
	Whether the unit is restarted up after stopping immediately?	Wait for 3min, and then turn on the unit again.
Poor cooling (heating)	Is the power too low?	Wait after voltage is resumed.
	Whether the air filter is too dirty?	Clean the air filter.
	Whether the set temperature is proper?	Adjust the temperature.
	Whether door and window are closed?	Close door and window.
Air conditioner can't receive signal from remote controller or remote controller is not sensible.	Whether the unit is interfered seriously (such as static pressure, unstable voltage)?	Please pull out the plug. Insert the plug after about 3 minutes, and then turn on the unit.
	Whether remote controller is within the receiving range?	The receiving range of remote controller is 8 m (26.25'). Do not exceed this range.
	Whether it's blocked by obstacles?	Remove the obstacles.
	Is sensitivity of remote controller low?	Check the batteries of remote controller. If the power is low, please replace the batteries.
	Whether there's fluorescence lamp in the room?	Move the remote controller close to air conditioner. Turn off the fluorescence lamp and try it again.
You can hear a knocking sound.	Whether the unit is turned on or turned off just now?	Heat expansion or shrinkage for the panel due to change of temperature, which cause friction sound.
There's abnormal sound during operation	Whether the unit is interfered by thunder, radio, etc?	Disconnect power, put through the power again, and then turn on the unit again.
There's off flavour	There's off-flavour source in the room, such as furniture, cigarette etc.	Eliminate the off-flavour source. Clean the filter.

Issue	Possible Causes	Solution
No air blown out from air conditioner	Whether air outlet or air inlet is blocked?	Eliminate the obstacles
	Under heating mode, whether indoor temperature increase set temperature?(Cool & Heat Unit only)	The unit will stop blowing fan after reaching set temperature.
	Whether heating mode is started up just now? (Cool & Heat Unit only)	In order to prevent cold air, air conditioner will delay for a while to be started up, which is the normal phenomenon.
	Whether evaporator is defrosted? (observe it by pulling out the filter)	It's the normal phenomenon. Air conditioner is defrosting. After defrosting is finished, it will resume operation.
Set temperature can't be adjusted.	Whether the required temperature exceeds the temperature setting range?	Temperature setting range: 61°F (16°C) - 86°F (30°C).
You can heard water-flowing sound	Whether the unit is turned on or turned off just now?	There's flowing sound of refrigerant inside the air conditioner, which is the normal phenomenon.

Malfunction code

Code	Solution
F1,F2,F4 F0	Please contact qualified professionals for service.
E8, H3	<ol style="list-style-type: none"> 1. Check if the unit is under high-temperature and high-humidity environment; if ambient temperature is too high, power off the unit and then energize it for operation after the ambient temperature drops to 95°F (35°C) below. 2. Check if the evaporator and condenser are blocked by some objects; if yes, take away the objects, power off the unit and then energize it for operation. 3. If the malfunction still occur, please contact our after-sales service center.
H8	<ol style="list-style-type: none"> 1. Pour out the water inside chassis. 2. If "H8" still exist, please contact professional person to maintain the unit.

WARNING

- If there're following phenomenon, please turn off the air conditioner and disconnect the power immediately, and then contact dealer immediately.
 - Power cord is overheating or damaged.
 - Abnormal sound during operation.
 - Off-flavour.
 - Water leakage.
- Do not repair or refit the air conditioner by yourself.
- If operate the air conditioner under abnormal condition, it may cause malfunction, electric shock or fire hazard.

Operation test

- Put through the power supply and then press ON/OFF button on remote controller to start the unit.
- Press mode button to select auto, cooling, drying, fan or heating function, and then check if the unit operates normally.
- If ambient temperature is below 61°F (16°C), the unit can't operate in cooling mode.

Electric schematic diagram

The electric schematic diagram are subject to change without notice. Please refer to which one on the unit.

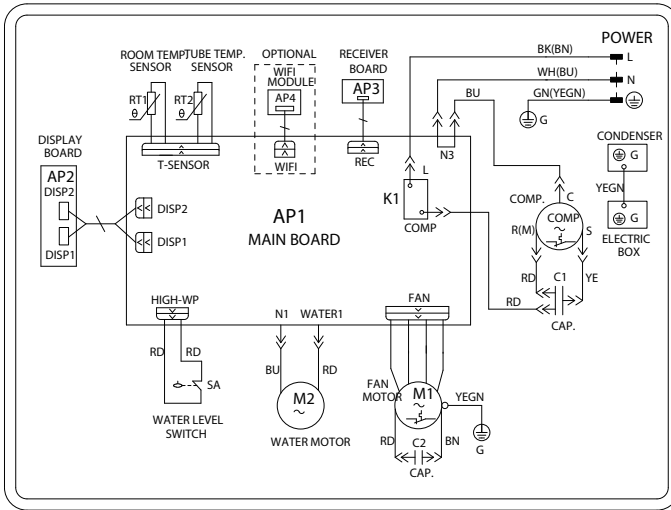

Specialist's manual

Aptitude requirement for maintenance man (repairs should be done only by specialists).

- a. Any person who is involved with working on or breaking into a refrigerant circuit should hold a current valid certificate from an industry-accredited assessment authority, which authorises their competence to handle refrigerants safely in accordance with an industry recognised assessment specification.
- b. Servicing shall only be performed as recommended by the equipment manufacturer. Maintenance and repair requiring the assistance of other skilled personnel shall be carried out under the supervision of the person competent in the use of flammable refrigerants.

Safety preparation work

The maximum refrigerant charge amount is shown on the following table A.

(Note: Please refer to the nameplate for the charging quantity of R32).

Table A – Maximum charge kg (lb)

Room area m ² (ft. ²)	Maximum charge kg (lb)
4 (43.06)	<0.921 (2.03)
7 (75.35)	1.181 (2.60)
9 (96.88)	1.519 (3.35)
11 (118.4)	1.842 (4.06)

Prior to beginning work on systems containing flammable refrigerants, safety checks are necessary to ensure that the risk of ignition is minimised. For repair to the refrigerating system, the following precautions shall be complied with prior to conducting work on the system.

Work procedure

Work shall be undertaken under a controlled procedure so as to minimise the risk of a flammable gas or vapour being present while the work is being performed.

General work area

All maintenance staff and others working in the local area shall be instructed on the nature of work being carried out. Work in confined spaces shall be avoided. The area around the workspace shall be sectioned off. Ensure that the conditions within the area have been made safe by control of flammable material.

Checking for presence of refrigerant

The area shall be checked with an appropriate refrigerant detector prior to and during work, to ensure the technician is aware of potentially toxic or flammable atmospheres. Ensure that the leak detection equipment being used is suitable for use with all applicable refrigerants, i.e. non-sparking, adequately sealed or intrinsically safe.

Presence of fire extinguisher

If any hot work is to be conducted on the refrigeration equipment or any associated parts, appropriate fire extinguishing equipment shall be available to hand. Have a dry powder or CO₂ fire extinguisher adjacent to the charging area.

No ignition sources

No person carrying out work in relation to a refrigeration system which involves exposing any pipe work shall use any sources of ignition in such a manner that it may lead to the risk of fire or explosion. All possible ignition sources, including cigarette smoking, should be kept sufficiently far away from the site of installation, repairing, removing and disposal, during which refrigerant can possibly be released to the surrounding space. Prior to work taking place, the area around the equipment is to be surveyed to make sure that there are no flammable hazards or ignition risks. "No Smoking" signs shall be displayed.

Ventilated area

Ensure that the area is in the open or that it is adequately ventilated before breaking into the system or conducting any hot work. A degree of ventilation shall continue during the period that the work is carried out. The ventilation should safely disperse any released refrigerant and preferably expel it externally into the atmosphere.

Checks to the refrigeration equipment

Where electrical components are being changed, they shall be fit for the purpose and to the correct specification. At all times the manufacturer's maintenance and service guidelines shall be followed. If in doubt, consult the manufacturer's technical department for assistance.

The following checks shall be applied to installations using flammable refrigerants:

- The actual refrigerant charge is in accordance with the room size within which the refrigerant containing parts are installed;
- The ventilation machinery and outlets are operating adequately and are not obstructed;
- If an indirect refrigerating circuit is being used, the secondary circuit shall be checked for the presence of refrigerant;
- Marking to the equipment continues to be visible and legible. Markings and signs that are illegible shall be corrected;
- Refrigeration pipe or components are installed in a position where they are unlikely to be exposed to any substance which may corrode refrigerant containing components, unless the components are constructed of materials which are inherently resistant to being corroded or are suitably protected against being so corroded.

Checks to electrical devices

Repair and maintenance to electrical components shall include initial safety checks and component inspection procedures. If a fault exists that could compromise safety, then no electrical supply shall be connected to the circuit until it is satisfactorily dealt with. If the fault cannot be corrected immediately but it is necessary to continue operation, an adequate temporary solution shall be used. This shall be reported to the owner of the equipment so all parties are advised.

Initial safety checks shall include:

- That capacitors are discharged: this shall be done in a safe manner to avoid possibility of sparking;
- That no live electrical components and wiring are exposed while charging, recovering or purging the system;
- That there is continuity of earth bonding.

Repairs to sealed components

During repairs to sealed components, all electrical supplies shall be disconnected from the equipment being worked upon prior to any removal of sealed covers, etc. If it is absolutely necessary to have an electrical supply to equipment during servicing, then a permanently operating form of leak detection shall be located at the most critical point to warn of a potentially hazardous situation.

Particular attention shall be paid to the following to ensure that by working on electrical components, the casing is not altered in such a way that the level of protection is affected. This shall include damage to cables, excessive number of connections, terminals not made to original specification, damage to seals, incorrect fitting of glands, etc.

Ensure that the apparatus is mounted securely.

Ensure that seals or sealing materials have not degraded to the point that they no longer serve the purpose of preventing the ingress of flammable atmospheres. Replacement parts shall be in accordance with the manufacturer's specifications.

Repair to intrinsically safe components

Do not apply any permanent inductive or capacitance loads to the circuit without ensuring that this will not exceed the permissible voltage and current permitted for the equipment in use.

Intrinsically safe components are the only types that can be worked on while live in the presence of a flammable atmosphere. The test apparatus shall be at the correct rating.

Replace components only with parts specified by the manufacturer. Other parts may result in the ignition of refrigerant in the atmosphere from a leak.

NOTE : The use of silicon sealant can inhibit the effectiveness of some types of leak detection equipment. Intrinsically safe components do not have to be isolated prior to working on them.

Cabling

Check that cabling will not be subject to wear, corrosion, excessive pressure, vibration, sharp edges or any other adverse environmental effects. The check shall also take into account the effects of aging or continual vibration from sources such as compressors or fans.

Detection of flammable refrigerants

Under no circumstances shall potential sources of ignition be used in the searching for or detection of refrigerant leaks. A halide torch (or any other detector using a naked flame) shall not be used.

The following leak detection methods are deemed acceptable for all refrigerant systems.

Electronic leak detectors may be used to detect refrigerant leaks but, in the case of FLAMMABLE REFRIGERANTS, the sensitivity may not be adequate, or may need re-calibration. (Detection equipment shall be calibrated in a refrigerant-free area.) Ensure that the detector is not a potential source of ignition and is suitable for the refrigerant used. Leak detection equipment shall be set at a percentage of the LFL of the refrigerant and shall be calibrated to the refrigerant employed, and the appropriate percentage of gas (25 % maximum) is confirmed.

Leak detection fluids are also suitable for use with most refrigerants but the use of detergents containing chlorine shall be avoided as the chlorine may react with the refrigerant and corrode the copper pipe-work.

NOTE

Examples of leak detection fluids are:

- Bubble method,
- Fluorescent method agents.

If a leak is suspected, all naked flames shall be removed/extinguished.

If a leakage of refrigerant is found which requires brazing, all of the refrigerant shall be recovered from the system, or isolated (by means of shut off valves) in a part of the system remote from the leak. Removal of refrigerant shall be according to Clause Removal and evacuation.

Removal and evacuation

When breaking into the refrigerant circuit to make repairs – or for any other purpose – conventional procedures shall be used. However, for flammable refrigerants it is important that best practice be followed, since flammability is a consideration. The following procedure shall be adhered to:

- a) Safely remove refrigerant following local and national regulations;
- b) Purge the circuit with inert gas;
- c) Evacuate (optional for A2L);
- d) Purge with inert gas (optional for A2L);
- e) Open the circuit by cutting or brazing.

The refrigerant charge shall be recovered into the correct recovery cylinders if venting is not allowed by local and national codes. For appliances containing flammable refrigerants, the system shall be purged with oxygen-free nitrogen to render the appliance safe for flammable refrigerants. This process might need to be repeated several times. Compressed air or oxygen shall not be used for purging refrigerant systems.

For appliances containing flammable refrigerants, refrigerants purging shall be achieved by breaking the vacuum in the system with oxygen-free nitrogen and continuing to fill until the working pressure is achieved, then venting to atmosphere, and finally pulling down to a vacuum (optional for A2L). This process shall be repeated until no refrigerant is within the system (optional for A2L). When the final oxygen-free nitrogen charge is used, the system shall be vented down to atmospheric pressure to enable work to take place.

Ensure that the outlet for the vacuum pump is not close to any potential ignition sources and that ventilation is available.

Charging procedures

In addition to conventional charging procedures, the following requirements shall be followed.

- Ensure that contamination of different refrigerants does not occur when using charging equipment. Hoses or lines shall be as short as possible to minimise the amount of refrigerant contained in them.
- Cylinders shall be kept in an appropriate position according to the instructions.
- Ensure that the refrigeration system is earthed prior to charging the system with refrigerant.
- Label the system when charging is complete (if not already).
- Extreme care shall be taken not to overfill the refrigeration system.
- Prior to recharging the system, it shall be pressure-tested with the appropriate purging gas.
- The system shall be leak-tested on completion of charging but prior to commissioning. A follow up leak test shall be carried out prior to leaving the site.

Decommissioning

Before carrying out this procedure, it is essential that the technician is completely familiar with the equipment and all its detail. It is recommended good practice that all refrigerants are recovered safely. Prior to the task being carried out, an oil and refrigerant sample shall be taken in case analysis is required prior to reuse of reclaimed refrigerant. It is essential that electrical power is available before the task is commenced.

- a) Become familiar with the equipment and its operation.
- b) Isolate system electrically.
- c) Before attempting the procedure, ensure that:
 - Mechanical handling equipment is available, if required, for handling refrigerant cylinders;
 - All personal protective equipment is available and being used correctly;
 - The recovery process is supervised at all times by a competent person;
 - Recovery equipment and cylinders conform to the appropriate standards.
- d) Pump down refrigerant system, if possible.
- e) If a vacuum is not possible, make a manifold so that refrigerant can be removed from various parts of the system.
- f) Make sure that cylinder is situated on the scales before recovery takes place.
- g) Start the recovery machine and operate in accordance with manufacturer's instructions.
- h) Do not overfill cylinders. (No more than 80 % volume liquid charge).
- i) Do not exceed the maximum working pressure of the cylinder, even temporarily.
- j) When the cylinders have been filled correctly and the process completed, make sure that the cylinders and the equipment are removed from site promptly and all isolation valves on the equipment are closed off.
- k) Recovered refrigerant shall not be charged into another refrigeration system unless it has been cleaned and checked.

Labelling

Equipment shall be labelled stating that it has been decommissioned and emptied of refrigerant. The label shall be dated and signed. For appliances containing flammable refrigerants, ensure that there are labels on the equipment stating the equipment contains flammable refrigerant.

Recovery

When removing refrigerant from a system, either for servicing or decommissioning, it is recommended good practice that all refrigerants are removed safely.

When transferring refrigerant into cylinders, ensure that only appropriate refrigerant recovery cylinders are employed. Ensure that the correct number of cylinders for holding the total system charge are available. All cylinders to be used are designated for the recovered refrigerant and labelled for that refrigerant (i.e. special cylinders for the recovery of refrigerant). Cylinders shall be complete with pressure-relief valve and associated shut-off valves in good working order. Empty recovery cylinders are evacuated and, if possible, cooled before recovery occurs.

The recovery equipment shall be in good working order with a set of instructions concerning the equipment that is at hand and shall be suitable for the recovery of all appropriate refrigerants including, when applicable, flammable refrigerants. In addition, a set of calibrated weighing scales shall be available and in good working order. Hoses shall be complete with leak-free disconnect couplings and in good condition. Before using the recovery machine, check that it is in satisfactory working order, has been properly maintained and that any associated electrical components are sealed to prevent ignition in the event of a refrigerant release. Consult manufacturer if in doubt.

The recovered refrigerant shall be returned to the refrigerant supplier in the correct recovery cylinder, and the relevant waste transfer note arranged. Do not mix refrigerants in recovery units and especially not in cylinders.

If compressors or compressor oils are to be removed, ensure that they have been evacuated to an acceptable level to make certain that flammable refrigerant does not remain within the lubricant. The evacuation process shall be carried out prior to returning the compressor to the suppliers. Only electric heating to the compressor body shall be employed to accelerate this process. When oil is drained from a system, it shall be carried out safely.

ASSISTANCE

Distributed by Ouellet Canada Inc.
1 877 247-3461

Before returning the unit to the retailer, for any problem related to the installation, use or proper functioning of the unit; contact our customer support department. One of our agents will guide you through the next steps.

Products have a limited warranty of one year upon presentation of proof of purchase.

Before calling for assistance or service, please check the troubleshooting section. It may save you the cost of a service call.

If you still need help, follow the instructions below. Please know the location and purchase date of your product. Please have in hand the complete model and serial number of your appliance. This information will help us to better respond to your request.

Please record the model and serial number information below. Also, make sure you keep the purchase invoice of your product.

Model Number _____

Serial Number _____

Purchase Date _____

Store Name _____